

ATLAS OF SALT DOMES IN THE EAST TEXAS BASIN

M. P. A. Jackson and Steven J. Seni

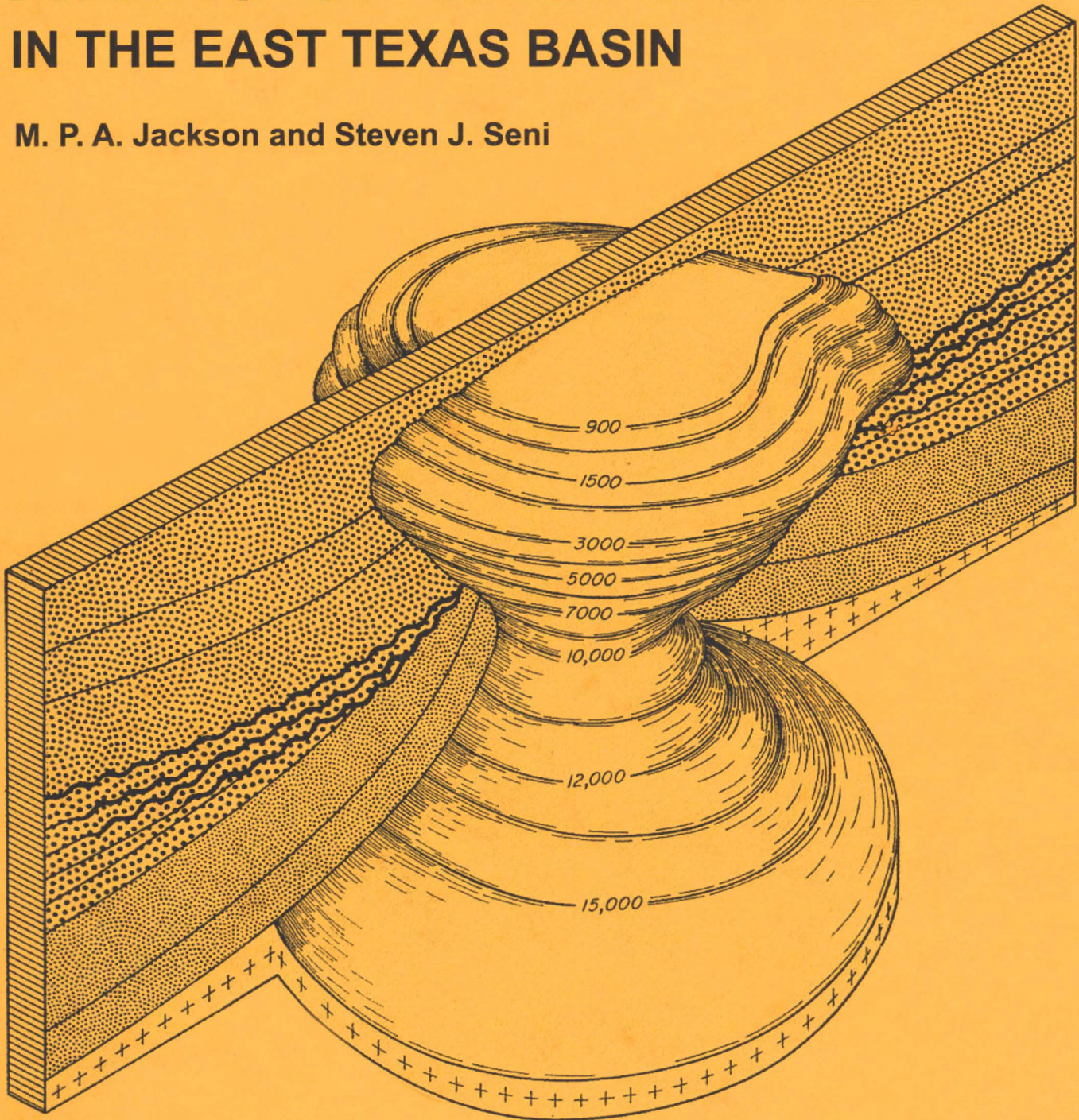

1984



Bureau of Economic Geology
W. L. Fisher, Director
The University of Texas at Austin
Austin, Texas 78713

Report of Investigations No. 140

ATLAS OF SALT DOMES IN THE EAST TEXAS BASIN

M. P. A. Jackson and Steven J. Seni

Project funded by the U. S. Department of Energy
under Contract No. DE-AC97-80ET46617



1984



Bureau of Economic Geology
W. L. Fisher, Director
The University of Texas at Austin
Austin, Texas 78713

CONTENTS

ABSTRACT	1
INTRODUCTION	1
REGIONAL GEOLOGY	2
EXPLANATION OF ATLAS TERMINOLOGY	10
Gravity Expression and Depth	10
Shape of Salt Stock	10
Dome Structure Adjacent to Salt Stock	17
Growth History	20
Structural and Hydrologic Stability	22
Resources	24
SIGNIFICANCE FOR EXPLORATION	24
ATLAS OF SALT DOMES	25
Bethel Dome	25
Boggy Creek Dome	30
Brooks Dome	35
Brushy Creek Dome	40
Bullard Dome	45
Butler Dome	50
East Tyler Dome	55
Grand Saline Dome	60
Hainesville Dome	65
Keechi Dome	71
Mount Sylvan Dome	76
Oakwood Dome	81
Palestine Dome	86
Steen Dome	91
Whitehouse Dome	96
ACKNOWLEDGMENTS	100
REFERENCES	100

Figures

1. Location map showing the East Texas Basin, Gulf Coast Basin, inland salt-diapir provinces, salt domes, and salt massifs	3
2. Generalized stratigraphic column, East Texas Basin	4
3. Map of structure on top of the Louann Salt or on top of the pre-Louann surface, showing the four salt provinces in the East Texas Basin	5
4. Isometric block diagrams of the East Texas Basin showing three-dimensional configuration of structure contours on top of the Louann Salt or on top of the pre-Louann surface where salt is thin or absent. (A) Northwest view. (B) Northeast view	6
5. Map showing distribution of salt diapirs, salt pillows, and turtle-structure anticlines in the East Texas Basin	8
6. Map showing spatial distribution of three age groups of salt diapirs and their surrounding secondary peripheral sinks in the East Texas Basin	9
7. Definition of diapir shape in plan view. (A) Major axis, minor axis, and major-axis azimuth. (B) Crestal area and percentage planar crest	11
8. Three classes of diapir shape in plan view defined by different axial ratios	11
9. Parameters describing inclined diapirs	12

10. Four classes of structural symmetry applicable to salt diapirs	13
11. Derivation of a shape parameter to differentiate between diapir crests with straight or slightly curved sides and crests with strongly curved sides	14
12. Quantitative classification of dome shape and a plot of dome shapes from the East Texas Basin	15
13. Classification of the slope of the sides of diapirs	16
14. Parameters describing diapir overhang	16
15. Definition of the size of a rim syncline and drag zone in cross section	17
16. Definition of maximum dip of strata and the dihedral angle between strata and the salt-stock flank	18
17. Classification of antithetic and homothetic (equivalent to synthetic) faults around salt stocks	19
18. Geometry and lithofacies characteristic of the three stages of salt-dome growth: pillow stage, diapir stage, and postdiapir stage	20
19. Qualitative classification of drainage systems above domes into four ideal types as a guide to relative movement of the land surface above	23
20. Map showing shape, location, topography, and drainage system of Bethel Dome	27
21. Isometric block diagram of Bethel salt stock	28
22. Orthogonal cross sections through major and minor axes of Bethel salt stock	28
23. Structural cross section through Bethel Dome	29
24. Map showing shape, location, topography, and drainage system of Boggy Creek Dome	32
25. Isometric block diagram of Boggy Creek salt stock	33
26. Orthogonal cross sections through major and minor axes of Boggy Creek salt stock ...	33
27. Structural cross section through Boggy Creek Dome	34
28. Map showing shape, location, topography, and drainage system of Brooks Dome	37
29. Isometric block diagram of Brooks salt stock	38
30. Cross section through Brooks salt stock, which is axially symmetric	38
31. Structural cross section through Brooks Dome	39
32. Map showing shape, location, topography, and drainage system of Brushy Creek Dome	42
33. Isometric block diagram of Brushy Creek salt stock	43
34. Cross section through Brushy Creek salt stock, which is axially symmetric	43
35. Structural cross section through Brushy Creek Dome	44
36. Map showing shapes, locations, topography, and drainage systems of Bullard and Whitehouse Domes	47
37. Isometric block diagram of Bullard salt stock	48
38. Orthogonal cross sections through major and minor axes of Bullard salt stock	48
39. Structural cross section through Bullard Dome	49
40. Map showing shape, location, topography, and drainage system of Butler Dome	52
41. Isometric block diagram of Butler salt stock	53
42. Orthogonal cross sections through major and minor axes of Butler salt stock	53
43. Structural cross section through Butler Dome	54
44. Map showing shape, location, topography, and drainage system of East Tyler Dome ...	57
45. Isometric block diagram of East Tyler salt stock	58
46. Orthogonal cross sections through major and minor axes of East Tyler salt stock	58
47. Structural cross section through East Tyler Dome	59
48. Map showing shape, location, topography, and drainage system of Grand Saline Dome	62
49. Isometric block diagram of Grand Saline salt stock	63
50. Orthogonal cross sections through major and minor axes of Grand Saline salt stock ...	63
51. Structural cross section through Grand Saline Dome	64
52. Map showing shape, location, topography, and drainage system of Hainesville Dome ..	67

53. Isometric block diagram of Hainesville salt stock	68
54. Orthogonal cross sections through major and minor axes of Hainesville salt stock	68
55. Structural cross section through Hainesville Dome, based on drilling data	69
56. Structural cross section through Hainesville Dome, based on seismic data	70
57. Map showing shape, location, topography, and drainage system of Keechi Dome	73
58. Isometric block diagram of Keechi salt stock	74
59. Orthogonal cross sections through major and minor axes of Keechi salt stock	74
60. Structural cross section through Keechi Dome and Concord Dome, a deep-diapir area	75
61. Map showing shape, location, topography, and drainage system of Mount Sylvan Dome	78
62. Isometric block diagram of Mount Sylvan salt stock	79
63. Orthogonal cross sections through major and minor axes of Mount Sylvan stock	79
64. Structural cross section through Mount Sylvan Dome	80
65. Map showing shape, location, topography, and drainage system of Oakwood Dome ...	83
66. Isometric block diagram of Oakwood salt stock	84
67. Orthogonal cross sections through major and minor axes of Oakwood salt stock	84
68. Structural cross section through Oakwood Dome, based on drilling and seismic data	85
69. Map showing shape, location, topography, and drainage system of Palestine Dome	88
70. Isometric block diagram of Palestine salt stock	89
71. Orthogonal cross sections through major and minor axes of Palestine salt stock	89
72. Structural cross section through Palestine Dome	90
73. Map showing shape, location, topography, and drainage system of Steen Dome	93
74. Isometric block diagram of Steen salt stock	94
75. Cross sections through Steen salt stock, which is axially symmetric	94
76. Structural cross section through Steen Dome	95
77. Isometric block diagram of Whitehouse salt stock	98
78. Orthogonal cross sections through major and minor axes of Whitehouse salt stock	98
79. Structural cross section through Whitehouse Dome	99

ABSTRACT

Data collected during the last 5 years on the 15 shallow salt diapirs that extend upward to shallow depths (<4,000 ft, 1,220 m) in the East Texas Basin are presented here in graphical and tabular form. East Texas Basin salt diapirs penetrate and have controlled the deformation of Jurassic and younger units in the central part of the basin. The regional geologic setting of the salt diapirs is summarized, and the meaning and significance of descriptive terms are discussed. This compendium contains both primary and secondary data. Primary data are observations of dome shape, depth, structure, and resources. Examples of primary data are depths to cap rock and salt, cross-sectional area and axial ratio, crestal area and percentage planar crest, axial plunge, tilt azimuth and tilt distance, structural symmetry, side convergence, overhang azimuth and overhang percentage, and a new quantitative classification of dome shape. The structural styles of strata around each dome are also described in terms of the size of the rim syncline and drag zone around the diapir, angular relations between the strata and the salt, and style of faulting. Hydrocarbon production histories, traps, and existing uses of each dome for storage or raw materials are summarized.

Secondary data include deductions and inferences based on the primary data. The growth evolution from the pillow stage, through the diapir stage, to the postdiapir stage is described, together with unconformities resulting from erosional breaching of the dome in the past. Structural stability and hydrologic integrity of each dome are assessed in terms of the age of the most recent known deformation. Geomorphic and hydrologic evidence of dome uplift, subsidence, or brine leakage is given, as is a new classification of drainage patterns above domes.

Keywords: cap rock, diapirs, East Texas Basin, halokinesis, petroleum, salt domes, salt tectonics, structural geology

INTRODUCTION

Salt domes are a unique class of geologic structures in a remarkable array of forms. The formation of salt structures by gravitationally induced flow has been the primary agent of deformation in the East Texas Basin, particularly for the Upper Jurassic and Lower Cretaceous strata above the Louann Salt. Throughout this century, salt domes have supplied rock salt from the central stock, sulfur from the overlying cap rock, and petroleum and associated gas from the many traps on the flanks and crests of the domes. New potential uses of salt domes continue to emerge. Salt caverns are easily and cheaply hollowed out by

solution or rock mining and are cost-effective storage vessels for liquefied petroleum gas, crude oil, liquid petroleum-based fuels, and toxic industrial wastes. The ongoing assessment of various rock types as potential repositories of high-level nuclear waste has encouraged considerable research into the lithology, geochemistry, hydrology, mechanics, and structure of salt domes. Other proposed future uses include storage of methane-producing urban trash and storage of off-peak electrical energy either as compressed air or as oxygen and hydrogen fuels derived by electrolytically disassociating water.

This publication summarizes pertinent information on the shallow salt domes of the East Texas Basin. Data were collected during a 5-year research program conducted by the Bureau of Economic Geology and funded by the U.S. Department of Energy. The program was designed to assess the suitability of these salt domes as repositories of nuclear waste. Results of the project have been presented in numerous reports, including annual progress reports (Kreitler and others, 1980, 1981) and a final summary report (Jackson and Seni, 1984).

Information was drawn from diverse sources, most of which are unpublished, and is presented in tables and figures to facilitate comparison of different domes. Terminology and classifications are defined and explained. This atlas of salt domes in the East Texas Basin is intended to be a reference work rather than a presentation of models of salt-dome formation. We provide observations of dome shape, structure, and resources, as well as inferred relations such as the history of dome growth, structural stability, and hydrologic stability of each dome.

REGIONAL GEOLOGY

The East Texas Basin is one of three Mesozoic basins flanking the northern part of the Gulf Coastal Plain (fig. 1). Basin stratigraphy is summarized in figure 2. During the Mesozoic opening of the Gulf of Mexico (Jackson and Seni, 1983), the East Texas Basin formed as a rift basin or rhomb graben on thinned continental crust. The Jurassic Louann Salt was deposited unconformably on a planar erosion surface across a basement of Paleozoic units and Triassic rift fill. The Louann Salt provided the source layer from which all the domes of East Texas grew. We estimate that its original thickness was as much as 5,000 to 7,000 ft (1,500 to 2,100 m).

After Louann deposition, platform carbonates and evaporites of the Smackover, Buckner, and Gilmer Formations slowly filled the basin, gradually prograding toward the basin center from the west, north, and east. Bossier, Schuler, and Hosston (Travis Peak) siliciclastics then prograded rapidly across these carbonates as deltas during the Late Jurassic - Early Cretaceous. Younger basin fill is composed of alternating marine carbonate and siliciclastic sediments.

All the salt diapirs occur in the middle of the basin, an area termed the "diapir province" (fig. 3). This province is surrounded by other provinces of more subtle, less mature structures. Toward the western and northern margins of the basin, virtually undeformed salt pinches out below the Mexia - Talco Fault Zone (fig. 4). Thin salt extends eastward, beyond the

basin and over the Sabine Arch, except for local pinch-outs on the eastern flank of the basin. Three types of anticlinal structures are related to salt flow in the East Texas Basin (fig. 5). (1) **Salt pillows** are broad, plano-convex domes of salt that represent a less mature, more primitive stage of salt-dome growth. The crest of the salt pillow is concordant with the overlying strata. We avoid describing these structures as "salt anticlines" because the base of the salt is flat, and thus the structures are not true anticlines. (2) **Salt diapirs** consist of a core of intrusive salt—the salt stock—surrounded in most instances by an aureole of domed sediments. All diapirs are discordant to their adjacent strata, but overlying strata can be concordant. Mature salt diapirs are commonly mushroom shaped, barrel shaped, conical, or spinelike. (3) **Turtle structures** can be salt cored, but their structure is a result of drape over clastic sediment thicks. Like a salt pillow, a turtle structure is laccolith shaped, having a roughly planar base and archlike crest. It represents a lens of thicker strata originally deposited in a salt-withdrawal basin adjoining a salt diapir. The basin was structurally inverted by subsidence of its margin caused by further withdrawal of salt into growing diapirs. Because of the thick clastic succession supporting it, the crest of the turtle structure remained elevated. The greater subsidence of the ends of the clastic lens relative to its center is responsible for its turtle shape in cross section.

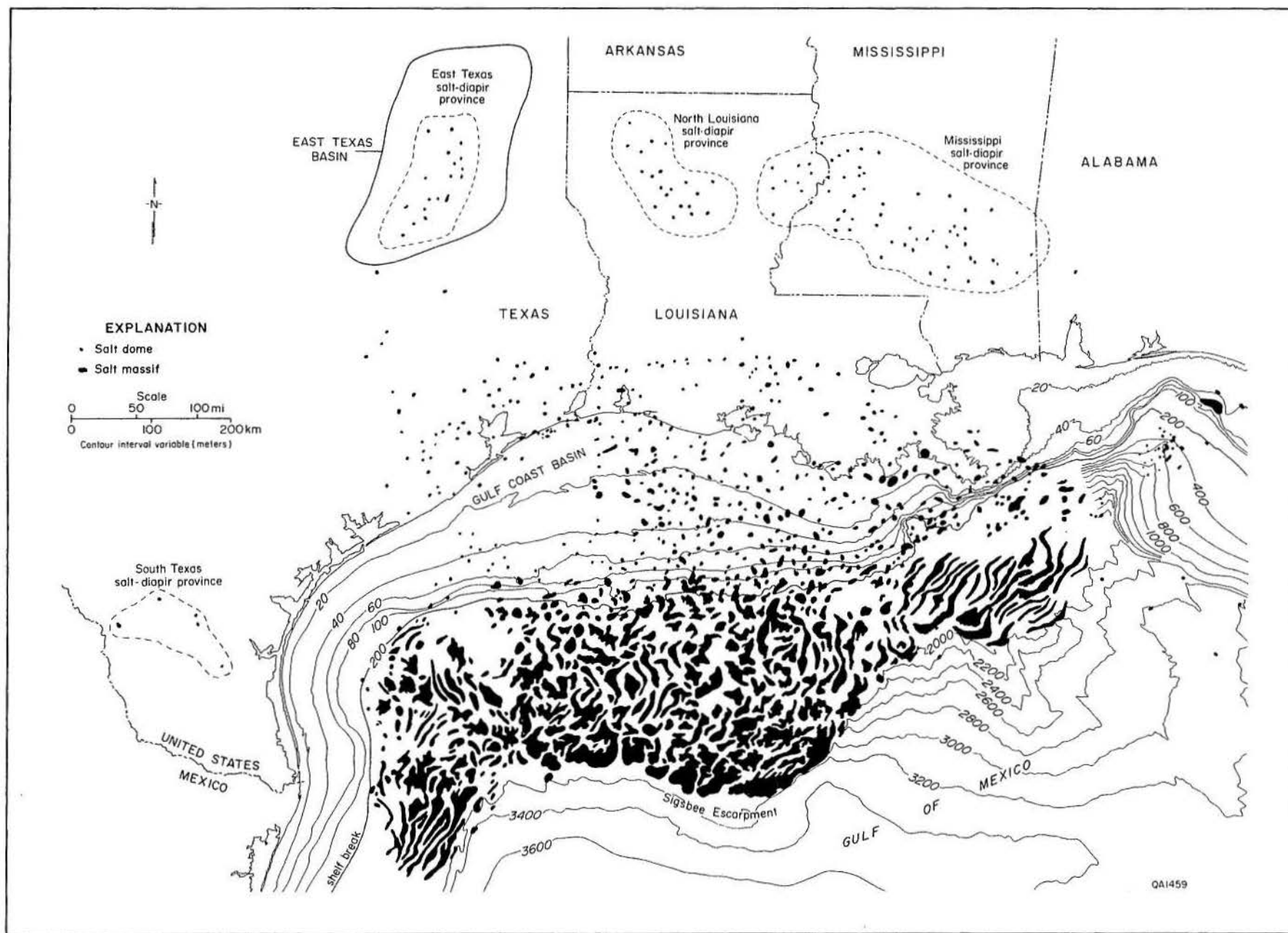

Figure 1. Location map showing the East Texas Basin, Gulf Coast Basin, inland salt-diapir provinces, salt domes, and salt massifs. (After Martin, 1978.)

By examining changes in the thickness and sedimentary facies of strata flanking the diapirs, we can reconstruct the growth history of each diapir (Seni and Jackson, 1983a, 1983b; 1984). Three age groups of diapirs have been recognized on the basis of the time that diapirs first pierced their overburdens (fig. 6). Group 1 became diapiric in the Early Cretaceous as a result of differential loading by Schuler-Hosston deltas. Group 2 became diapiric in the mid-Cretaceous during the time of maximum sedimentation in the center of the basin, gradually migrating northward along the basin axis. Group 3 diapirs pierced overburden in the Late Cretaceous. Studies of salt-dome growth rates indicate that by Early Tertiary time the domes of the East Texas Basin reached a mature stage of growth characterized by slow, steadily declining rates of rise, estimated to be less than 0.1 mm per year (Seni and Jackson, 1983a, 1983b).

Understanding of the hydrocarbon potential of the Jurassic section of the diapir province of the East Texas Basin is limited mainly by lack of deep-drill data. Salt folds in the deep, flared pedestals of diapirs may constitute a play. Jurassic carbonates along the deep diapir flanks are also potential sources of hydrocarbons because of possible high-energy grainstone and reef facies that developed during the pillow stage of growth. Between the salt diapirs, the Louann Salt is absent or too thin to be resolved seismically; the absence of salt pillows in the diapir province removes this principal type of anticlinal structure from consideration for exploration. Deep turtle structures remain a favorable structural target for hydrocarbons in Jurassic carbonates and a highly favorable structural-stratigraphic target for thick sandstones in the Jurassic - Lower Cretaceous Schuler-Hosston terrigenous clastics.

Figure 2. Generalized stratigraphic column, East Texas Basin. (From Wood and Guevara, 1981.)

ERA-THEM	SYSTEM	SERIES	GROUP	FORMATION		
CENOZOIC	TERTIARY	EOCENE	CLAIBORNE	YEGUA		
				COOK MOUNTAIN		
				SPARTA		
				WECHES		
				QUEEN CITY		
		PEKI LAW				
		CARRIZO				
		PALEOCENE	WILCOX	UNDIFFERENTIATED		
				MIDWAY	UNDIFFERENTIATED	
		MESOZOIC	CRETACEOUS	UPPER CRETACEOUS	NAVARRO	UPPER NAVARRO CLAY
UPPER NAVARRO MARL						
MACATOCH SAND						
LOWER NAVARRO						
TAYLOR	UPPER TAYLOR					
	PECAN GAP CHALK					
	WOLFE CITY SAND					
AUSTIN	LOWER TAYLOR					
	GOBER CHALK					
	BROWSTOWN					
EAGLE FORD	BLOSSOM SAND					
	BDNHAM CLAY					
	Glaucconitic Chalk Stringer					
WOODBINE	AUSTIN CHALK					
	Ector Chalk Mbr.					
	Sub Clarksville Mbr.					
LOWER CRETACEOUS	TRINITY	EAGLE FORD	EAGLE			
			FORD			
		WOODBINE	WOODBINE			
			Dexter Sand Mbr.			
		WASHITA	Lewisville Mbr.			
			MANESS SHALE			
			BUDA LIMESTONE			
			GRAYSON SHALE			
			MAIN STREET LIMESTONE			
			WENO-PAW PAW LIMESTONE			
DENTON SHALE						
FORT WORTH LIMESTONE						
DUCK CREEK SHALE						
DUCK CREEK LIMESTONE						
KIAMICHI SHALE						
GOODLAND LIMESTONE						
UPPER JURASSIC	COTTON VALLEY	FREDERICKSBURG	PALUXY			
			UPPER GLEN ROSE			
			MASSIVE ANHYDRITE			
			Rodessa Member			
			James Limestone Mbr.			
			Pine Island Shale Member			
			Pettet (Sigal) Member			
			TRAVIS PEAK (HOSSTON)			
			MIDDLE JURASSIC	LOUARK	LOUANN	SCHULER
						BOSSIER
UPPER JURASSIC	LOUARK	LOUANN	GILMER LIMESTONE			
			(COTTON VALLEY LIMESTONE)			
MIDDLE JURASSIC	LOUARK	LOUANN	BUCKNER			
			SMACKOVER			
UPPER JURASSIC	LOUARK	LOUANN	NORPHLET			
			LOUANN SALT			
UPPER JURASSIC	LOUARK	LOUANN	WERNER			
			EAGLE MILLS			
PALEOZOIC				DUACHITA		

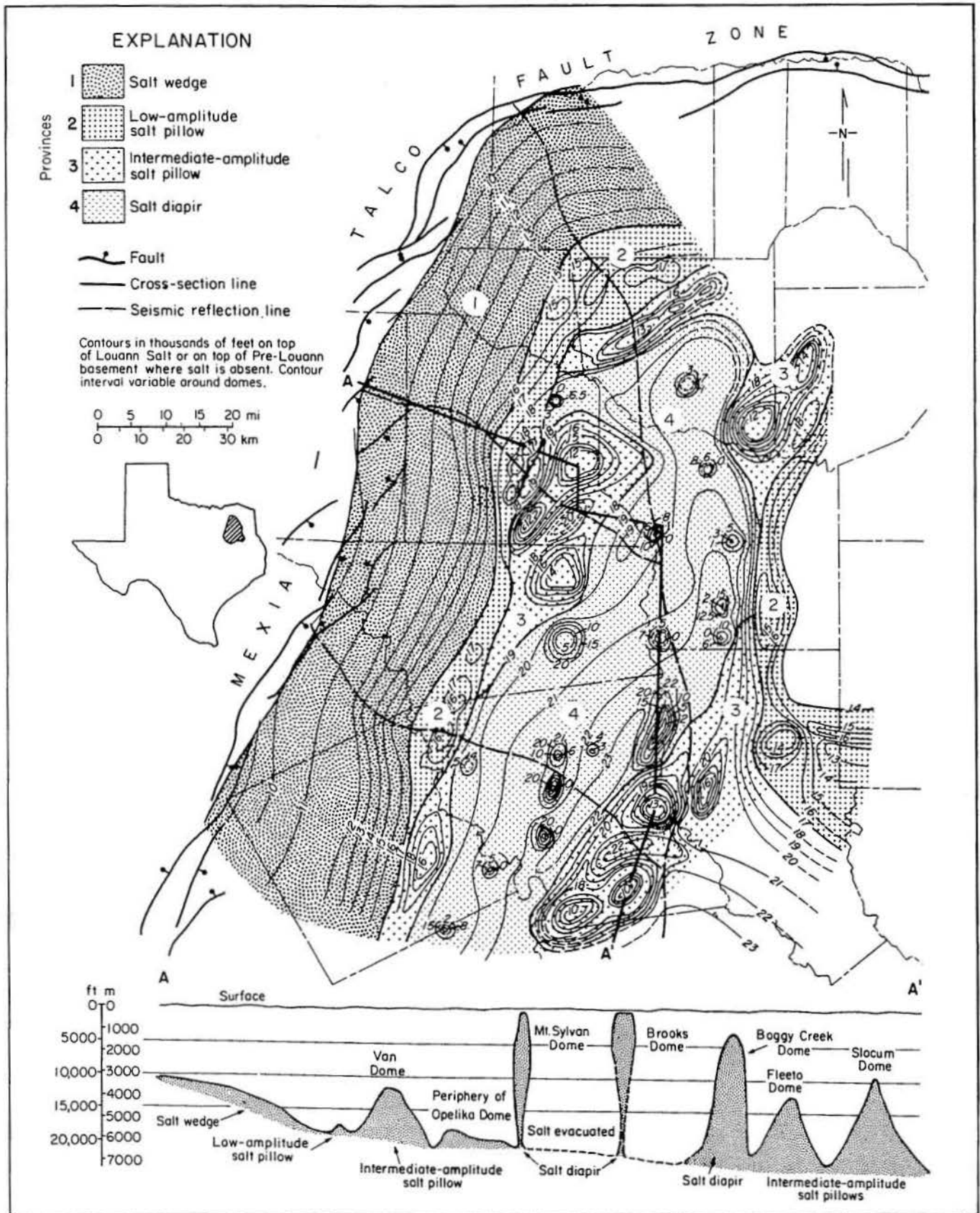
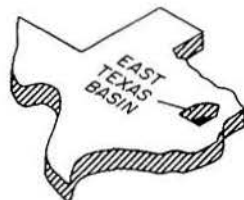
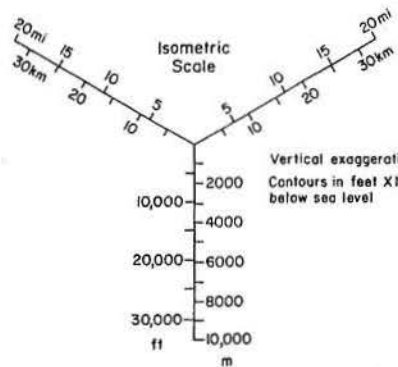

Figure 3. Map of structure on top of the Louann Salt or on top of the pre-Louann surface, showing the four salt provinces in the East Texas Basin. Seismic control and line of cross section A-A' (below) are also indicated. (From Seni and Jackson, 1984.)



A

Updip limit of Louann Salt

Base of salt

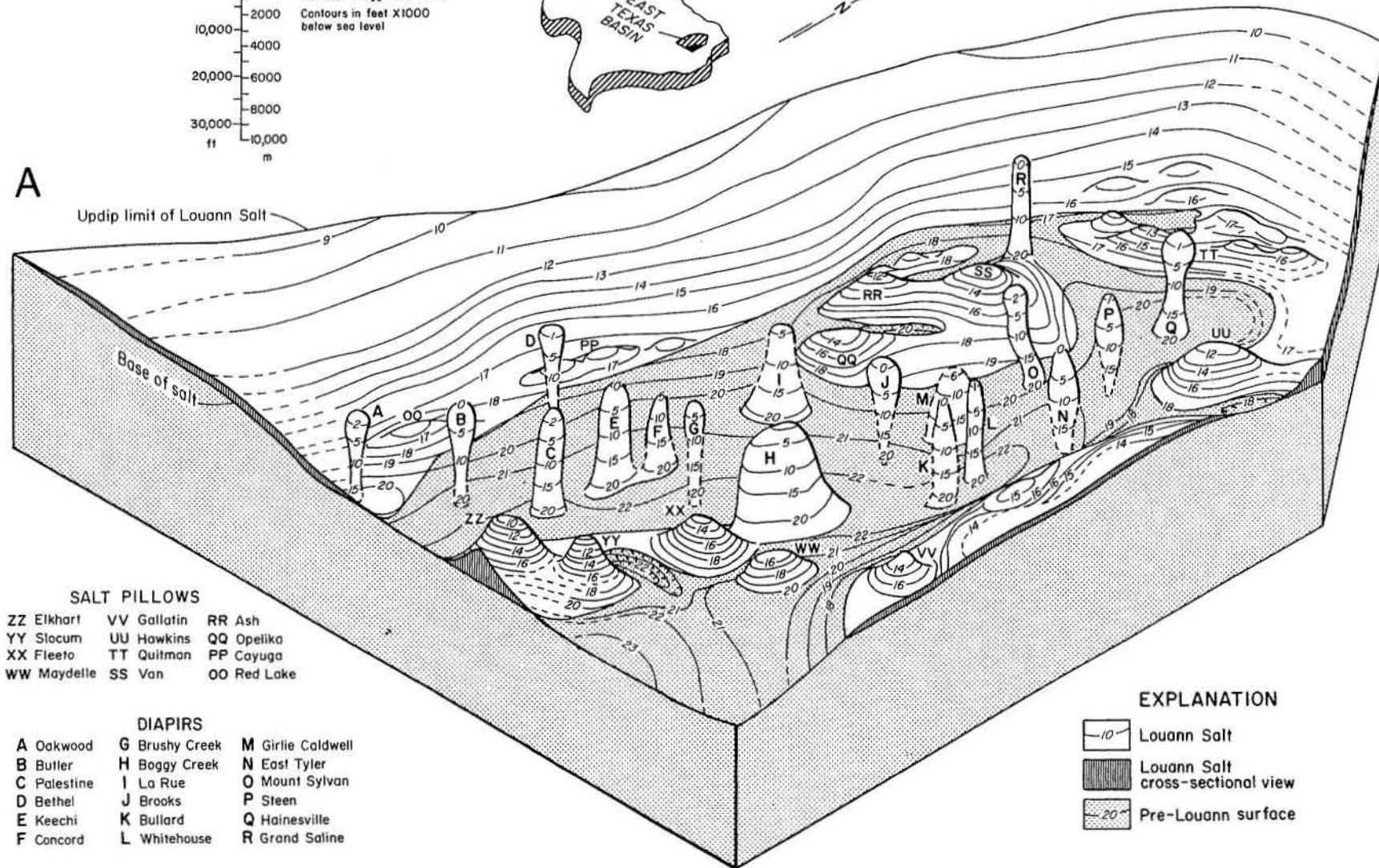

SALT PILLOWS

ZZ Elkhart	VV Gallatin	RR Ash
YY Slocum	UU Hawkins	QQ Opelika
XX Fleeto	TT Quitman	PP Cayuga
WW Maydelle	SS Van	OO Red Lake

DIAPIRS

A Oakwood	G Brushy Creek	M Girlie Caldwell
B Butler	H Boggy Creek	N East Tyler
C Palestine	I La Rue	O Mount Sylvan
D Bethel	J Brooks	P Steen
E Keechi	K Bullard	Q Hainesville
F Concord	L Whitehouse	R Grand Saline

EXPLANATION

	Louann Salt
	Louann Salt cross-sectional view
	Pre-Louann surface

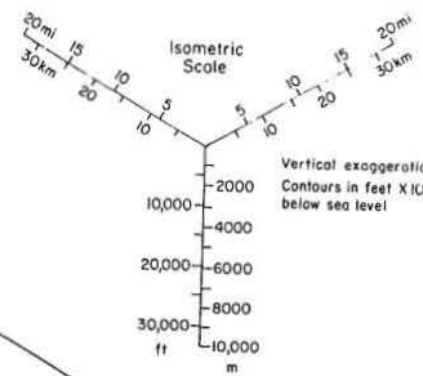

B

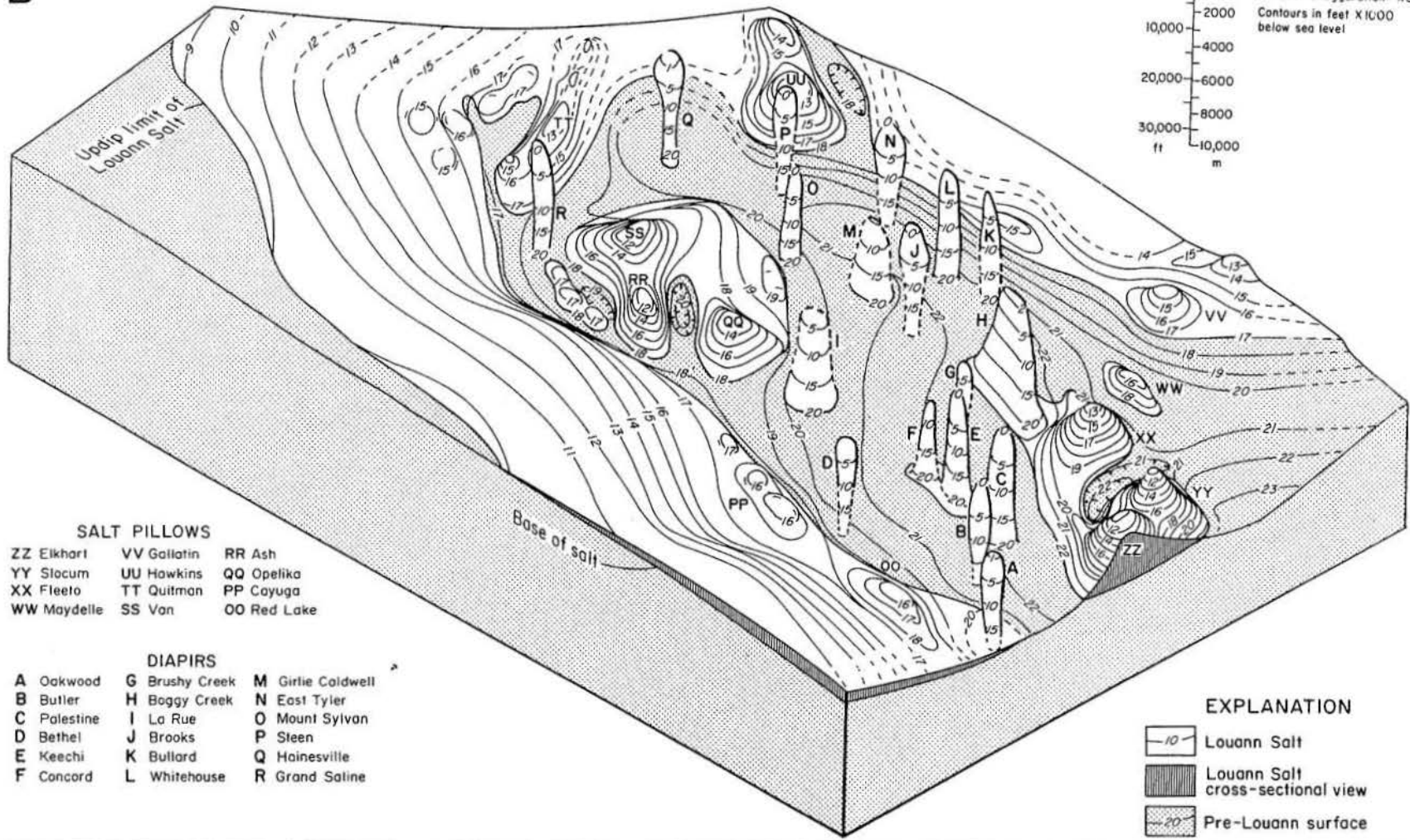

SALT PILLOWS

- | | | |
|-------------|-------------|-------------|
| ZZ Elkhart | VV Gallatin | RR Ash |
| YY Stocum | UU Hawkins | QQ Opelika |
| XX Fleeto | TT Quitman | PP Coyuga |
| WW Maydelle | SS Van | OO Red Lake |

DIAPIRS

- | | | |
|-------------|----------------|-------------------|
| A Oakwood | G Brushy Creek | M Girlie Caldwell |
| B Butler | H Boggy Creek | N East Tyler |
| C Palestine | I La Rue | O Mount Sylvan |
| D Bethel | J Brooks | P Steen |
| E Keechi | K Bullard | Q Hainesville |
| F Concord | L Whitehouse | R Grand Saline |

EXPLANATION

- Louann Salt
- Louann Salt cross-sectional view
- Pre-Louann surface

Figure 4. Isometric block diagrams of the East Texas Basin showing three-dimensional configuration of structure contours on top of the Louann Salt or on top of the pre-Louann surface where salt is thin or absent. Where indicated as "absent," the Louann Salt is too thin to be seismically resolved into a discrete unit or is too thin to supply further salt to diapirs; its actual thickness here may be as much as a few hundred feet. (A) Northwest view. (B) Northeast view. Constructed by isometric projection and incremental translation of contours, following Lobeck (1924, p. 138-142). (A) From Jackson and Seni (1983). (B) From Seni and Jackson (1984).

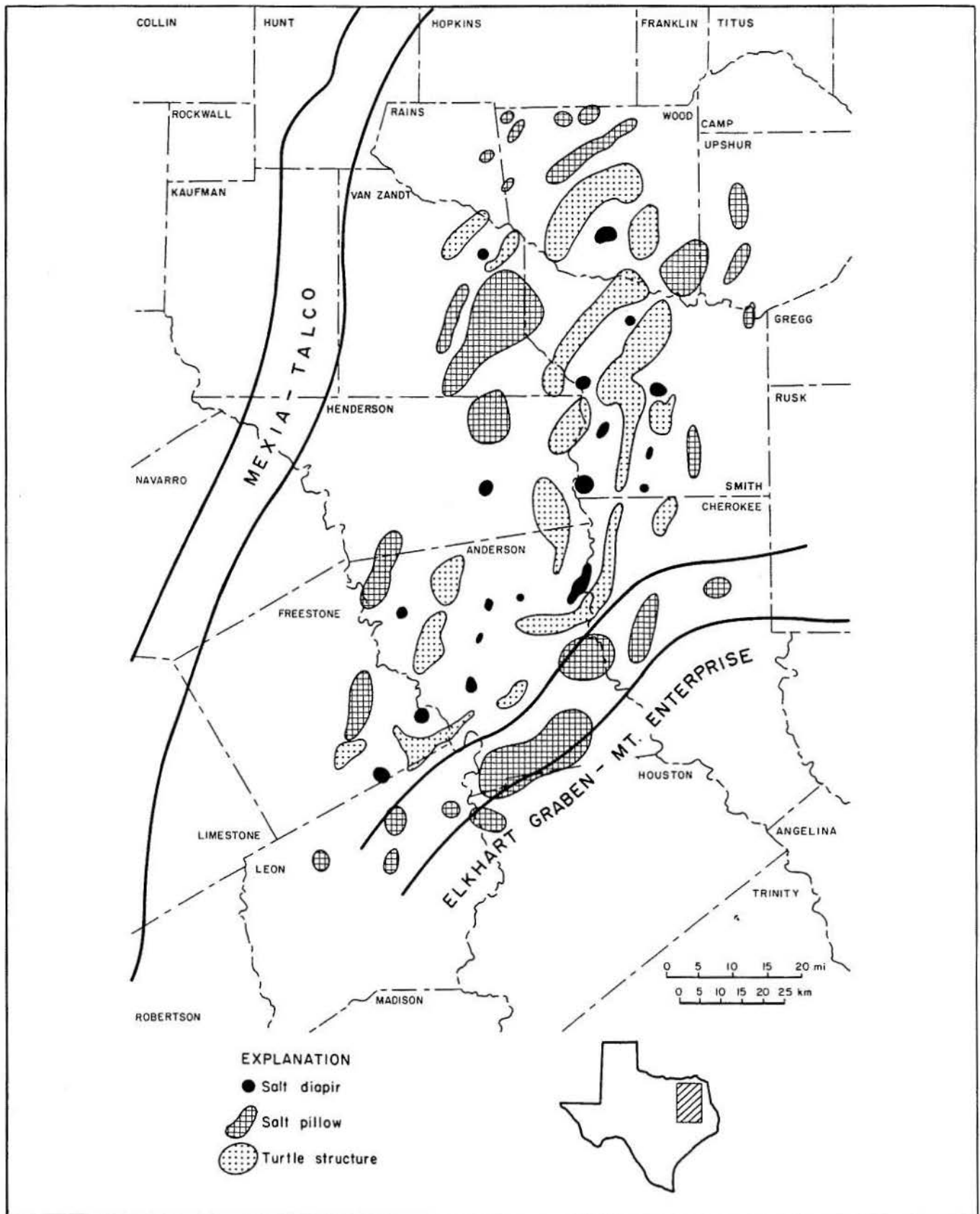

Figure 5. Map showing distribution of salt diapirs, salt pillows, and turtle-structure anticlines in the East Texas Basin. La Rue, Concord, and Girlie Caldwell salt diapirs have been omitted from this atlas because of the great depths—4,450 ft (1,356 m), 6,000 ft (1,829 m), and 6,002 ft (1,830 m), respectively—to their crests.

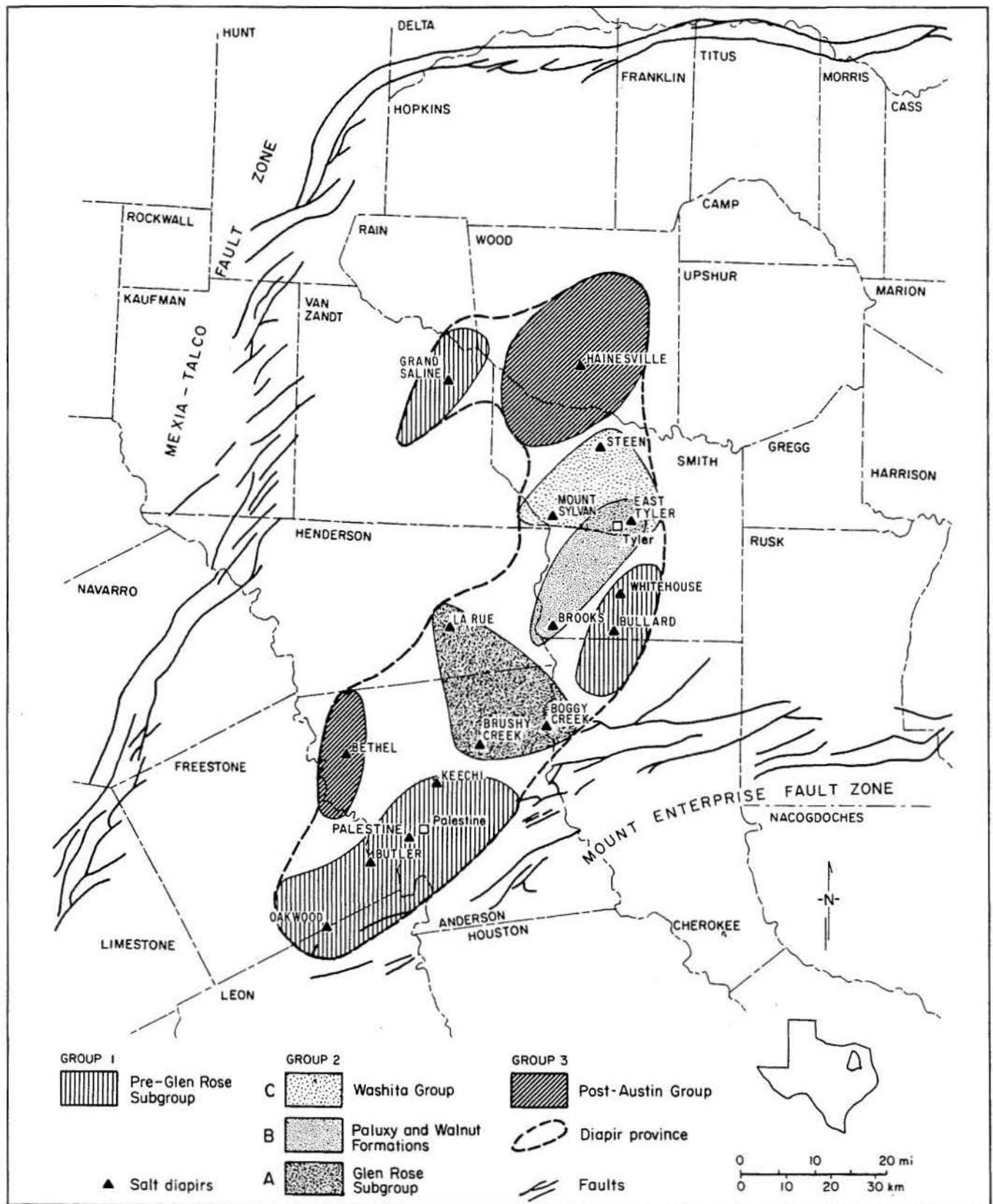

Figure 6. Map showing spatial distribution of three age groups of salt diapirs and their surrounding secondary peripheral sinks (ornamented) in the East Texas Basin. Group 1 is the oldest, group 3 is the youngest. La Rue Dome, which is not covered in this atlas, is included to show its age relationship to the shallow domes. Note the gradual migration of group 2 subgroups toward the northern group-3 area. The Mexia-Talco Fault Zone defines the northern and western margin of the basin and marks the approximate updip limit of Louann Salt. (From Seni and Jackson, 1983b.)

EXPLANATION OF ATLAS TERMINOLOGY

The 15 salt domes in the East Texas Basin less than 4,000 ft (1,220 m) deep are Bethel, Boggy Creek, Brooks, Brushy Creek, Bullard, Butler, East Tyler, Grand Saline, Hainesville, Keechi, Mount Sylvan, Oakwood, Palestine, Steen, and Whitehouse. For each dome there are (1) data in outline form, described in this section; (2) a map of surface topography over the dome showing structure contours drawn on the salt stock, as constructed from gravity and drill data by A. B. Giles (figs. 20, 24, 28, 32, 40, 44, 48, 52, 69, 73); Netherland, Sewell and Associates (1976) (figs. 36 and 61), and Exploration Techniques (1979) (figs. 57 and 65); (3) an isometric block diagram of the salt stock; (4) two orthogonal cross sections through the salt stock oriented along the major and minor axes;

and (5) a structural cross section across the dome (all prepared by A. B. Giles and previously published in Giles and Wood, 1981; Wood and Giles, 1982; and Giles and Wood, 1983) illustrating the configuration of adjacent strata, based on drilling data, and augmented in the case of Oakwood, Mount Sylvan, and Hainesville Domes by seismic reflection data.

To categorize each dome as fully as possible, a large number of terms were drawn from diverse sources. Many of these terms require definition and are discussed below. Where appropriate, sources of data and terminology are given; terminology and classifications that are unreferenced were developed specifically for this study. Geologic ages are given in millions of years (Ma) before the present.

Gravity Expression and Depth

Residual gravity expression is given in gravity units (1 G unit = 10^{-1} milligal = 10^{-6} m/s²), based on data from Exploration Techniques (1979). Residual gravity is the portion of the local gravity acceleration remaining after adjustment of the local measured acceleration for latitude and after the free-air and Bouguer corrections.

Minimum **depths**, in feet (meters) below the topographic surface, are given to the top of the cap rock and the top of the salt stock. The approximate depth to the Louann Salt source layer ("mother salt") is derived from regional seismic data. **Elevations** on structure-contour maps are given in feet (meters) below mean sea level.

Shape of Salt Stock

Several related parameters describing the **size**, **orientation**, and **shape** of the salt stock can be derived from maps of structure contours drawn on top of the salt. **Major axis**, **a**, **minor axis**, **b**, and **major-axis azimuth** γ are defined in figure 7A. The **diapir axis** is a straight "line of best fit" joining the center of successive horizontal cross sections through the salt stock. The diapir axis is not necessarily vertical.

Maximum cross-sectional area was measured by planimeter. It is approximately equal to $\pi ab/4$ if the cross-sectional shape is treated as elliptical, where **a** is the major axis and **b** is the minor axis.

Crestal area of a salt stock in most cases corresponds to the area enclosed within the highest structure contour, as measured by

planimeter (fig. 7B). In some cases the limits of the crest are placed at the line of abrupt steepening, as evidenced by narrowing of contours, even if the crest area includes more than one widely spaced contour. The **percentage planar crest** is proportional to the ratio between the crestal area and the maximum cross-sectional area (fig. 7B).

The degree of **ellipticity**, which corresponds to the **axial ratio** (fig. 8), enables the plan shape of the salt stocks to be divided into three groups: **circular**, **elliptical**, and **highly elliptical**.

Diapirs whose axes are not vertical can be described in terms of **axial plunge**, **axial tilt azimuth**, and **tilt distance** (fig. 9). The concept of **structural symmetry** has long been used to characterize the three-dimensional shape of

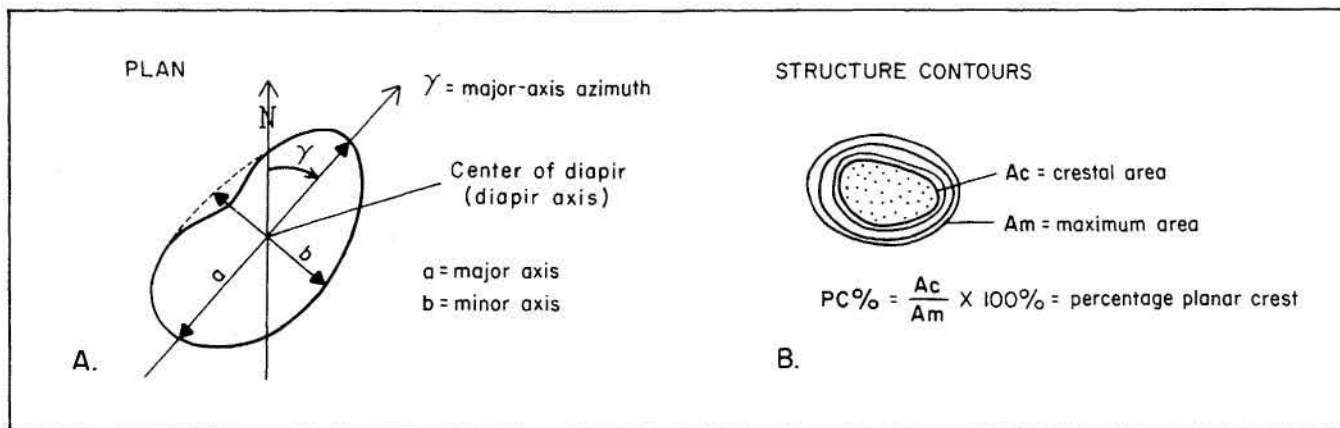

Figure 7. Definition of diapir shape in plan view. (A) Major axis, minor axis, and major-axis azimuth. (B) Crestal area and percentage planar crest. Areas can be measured by planimeter.

geologic structures (Turner and Weiss, 1963; Wilson, 1982) and is applied here to salt stocks (fig. 10).

The shape of the crest of a salt stock is visible both in cross sections and in isometric block diagrams. Shape provides clues both to the dynamics of salt intrusion and to the prevalence of dissolution of salt by ground water. For instance, a conical shape suggests active intrusion of a central spine or its protection from dissolution by a small central cap rock. Conversely, a planar crest suggests that either the crest has been planed off by dissolution because it projects upward into an aquifer or that upward intrusion has been

impeded for one or more of the following three reasons: the crest is overlain by an impenetrable layer, the crest is surrounded by a layer of equal or lower density, or the crest reached the surface and was subsequently buried (Ramberg, 1981, p. 260).

The shape of a dome crest in cross section is a function of two independent variables: the percentage planar crest (fig. 7B) in plan view and the curvature of the crest shoulder in cross section. Figure 11A shows how the curvature of an arc between any two points can be determined. The crest of a salt stock is geometrically (not mechanically) analogous to a folded surface. The hinge zone of a fold has

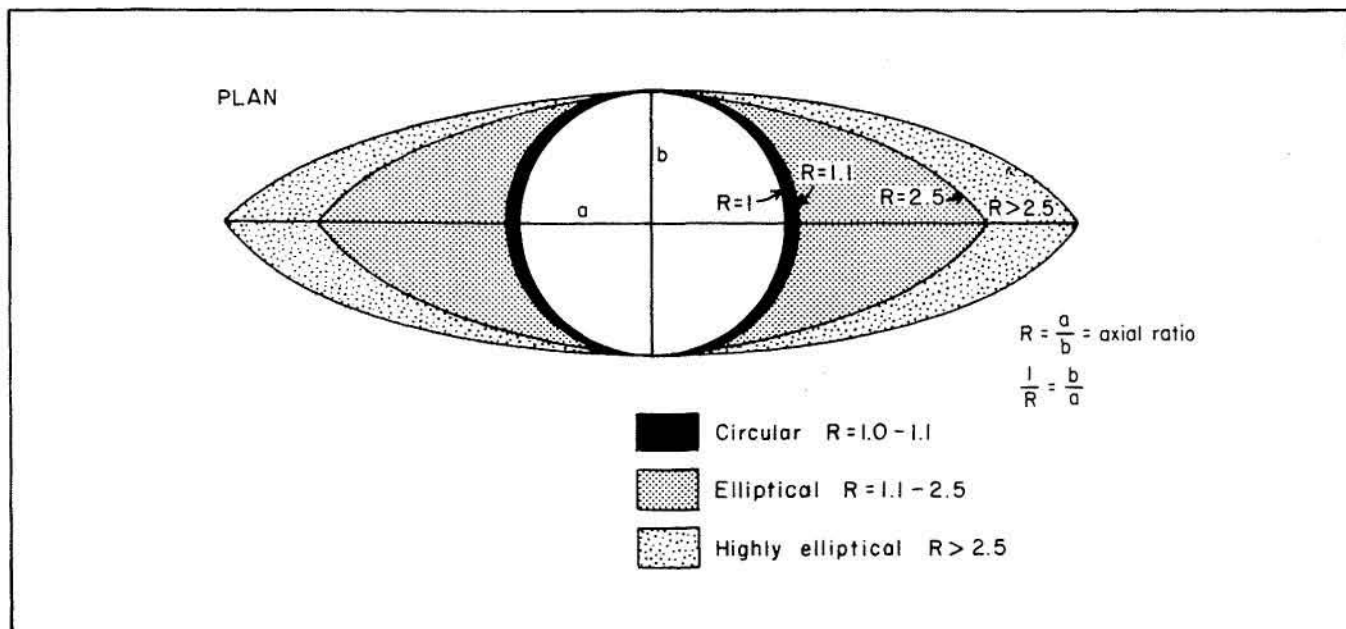

Figure 8. Three classes of diapir shape in plan view defined by different axial ratios.

been defined as "that part of a fold where the curvature of the folded surface exceeds that of a circular arc of diameter equal to the distance between the inflection points of the fold" (Ramsay, 1967, p. 349). This definition can be adapted to salt stocks by substituting the points S_1 and S_2 , which represent the base of the crest in profile, for the fold inflection points (fig. 11B). Straight or slightly curved parts are analogous to fold limbs, whereas strongly curved parts are analogous to hinge zones. Differentiation between these parts enables the overall shape to be quantified by means of the shape parameter, P , adapted from the fold parameter, P_1 , as defined by Ramsay (1967, p. 350). Values of P range from large negative to large positive numbers. But effectively these limits are -1 to 1 because only highly idealized theoretical shapes have values beyond these limits. These limits of -1 and 1 correspond to convexly curved domical crests and straight-sided conical crests, respectively. Shape can be determined independently of the percentage planar crest, as shown in figure 11C.

Figure 12 shows how these parameters can be combined into a quantitative classification of dome shape. Using the 3 end members, planar, convex, and conical (fig. 12, upper triangles), the range of possible dome shapes can be divided into 10 fields, of which 5 are represented by domes in the East Texas Basin. The lower triangles in figure 12, which plot the shape parameter against the ellipticity of the dome (fig. 8), combine elements of cross-sectional shape with plan shape, thus allowing differentiation of domes of similar cross-section shape but dissimilar plan shape. For examples, note the Mount Sylvan and Boggy Creek Domes (fig. 12).

The presence and position of the salt stock **overhang** determine whether the sides of the stock are **parallel** (no overhang), **upward diverging** (below overhang), or **upward converging** (above overhang or no overhang) (fig. 13). If an overhang exists, the **azimuth of maximum overhang**, the **overhang area**, the **overhang distance**, and the **percentage overhang** are recorded (fig. 14).

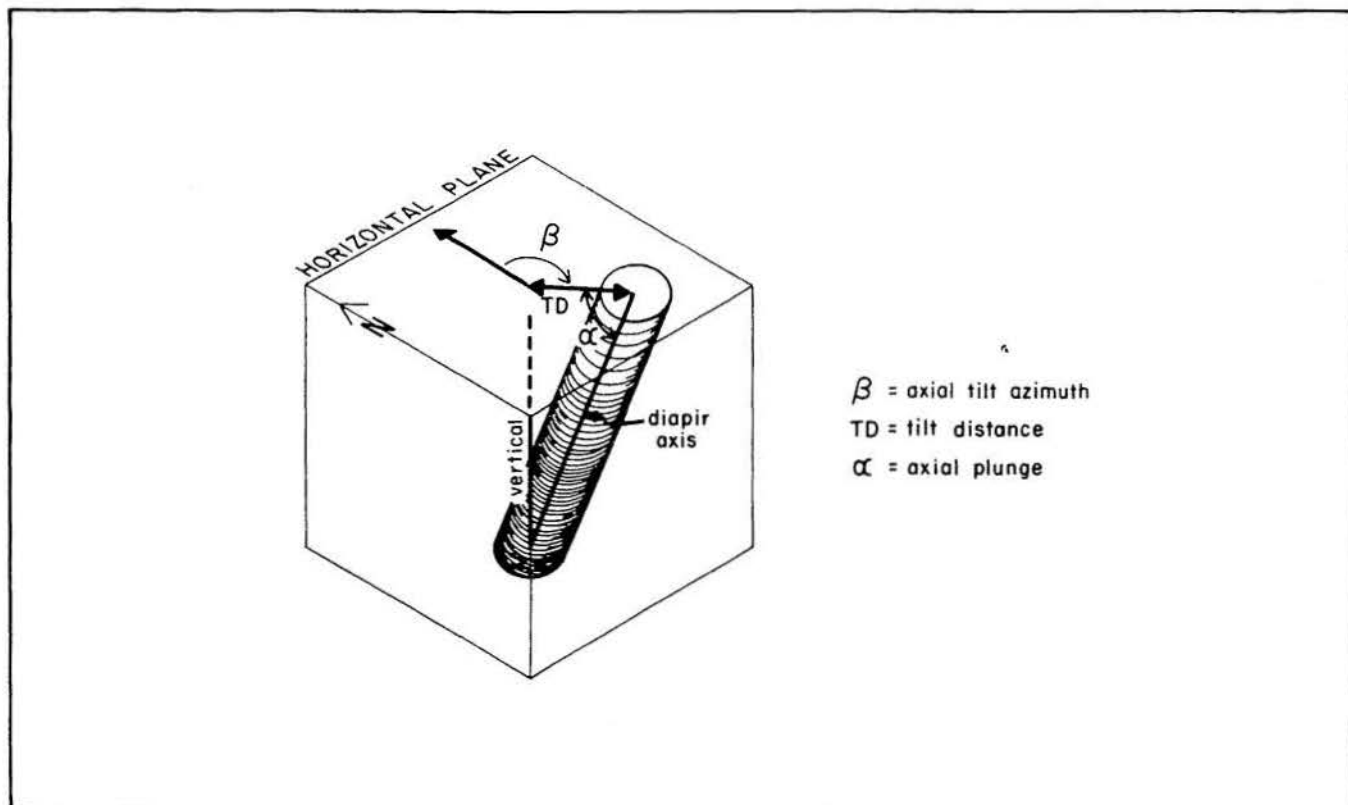
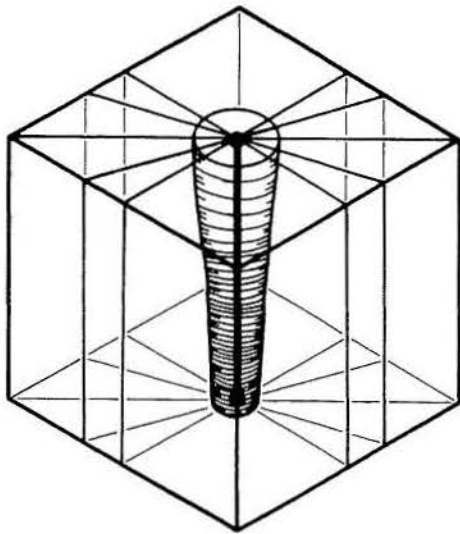
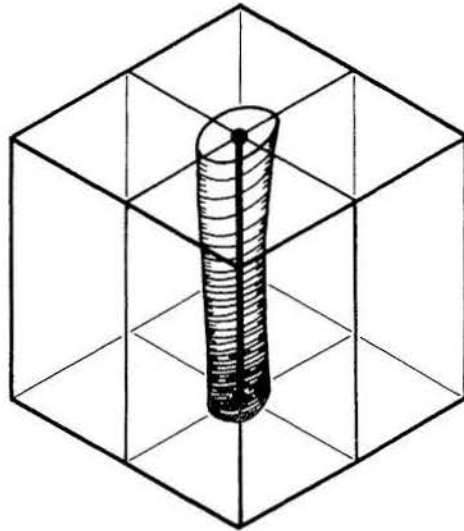

Figure 9. Parameters describing inclined diapirs. These are calculated from structure-contour maps drawn on the salt.



Axial - infinite number of axial planes of symmetry, one axis of symmetry



Orthorhombic - two axial planes of symmetry, one axis of symmetry

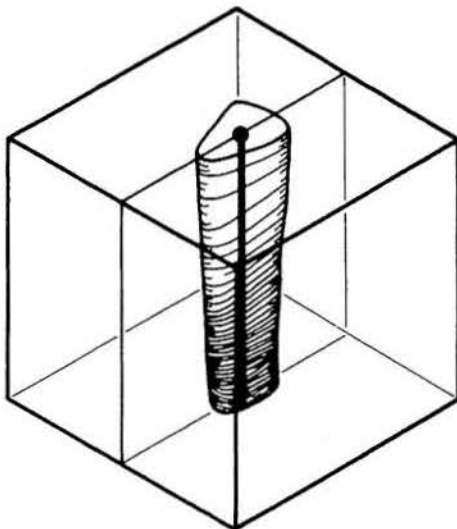

Monoclinic - one axial plane of symmetry, one axis of symmetry

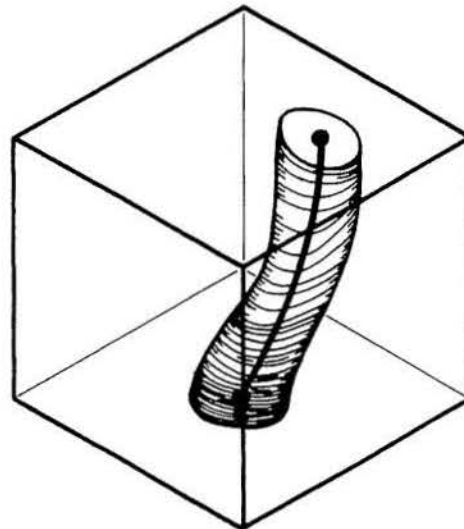

Triclinic - no axial planes or axes of symmetry

Figure 10. Four classes of structural symmetry applicable to salt diapirs. Structural symmetry is independent of inclination of the diapir from the vertical. The heavy line through the core of the diapir is the axis except in the triclinic example, in which the line is shown for comparison only.

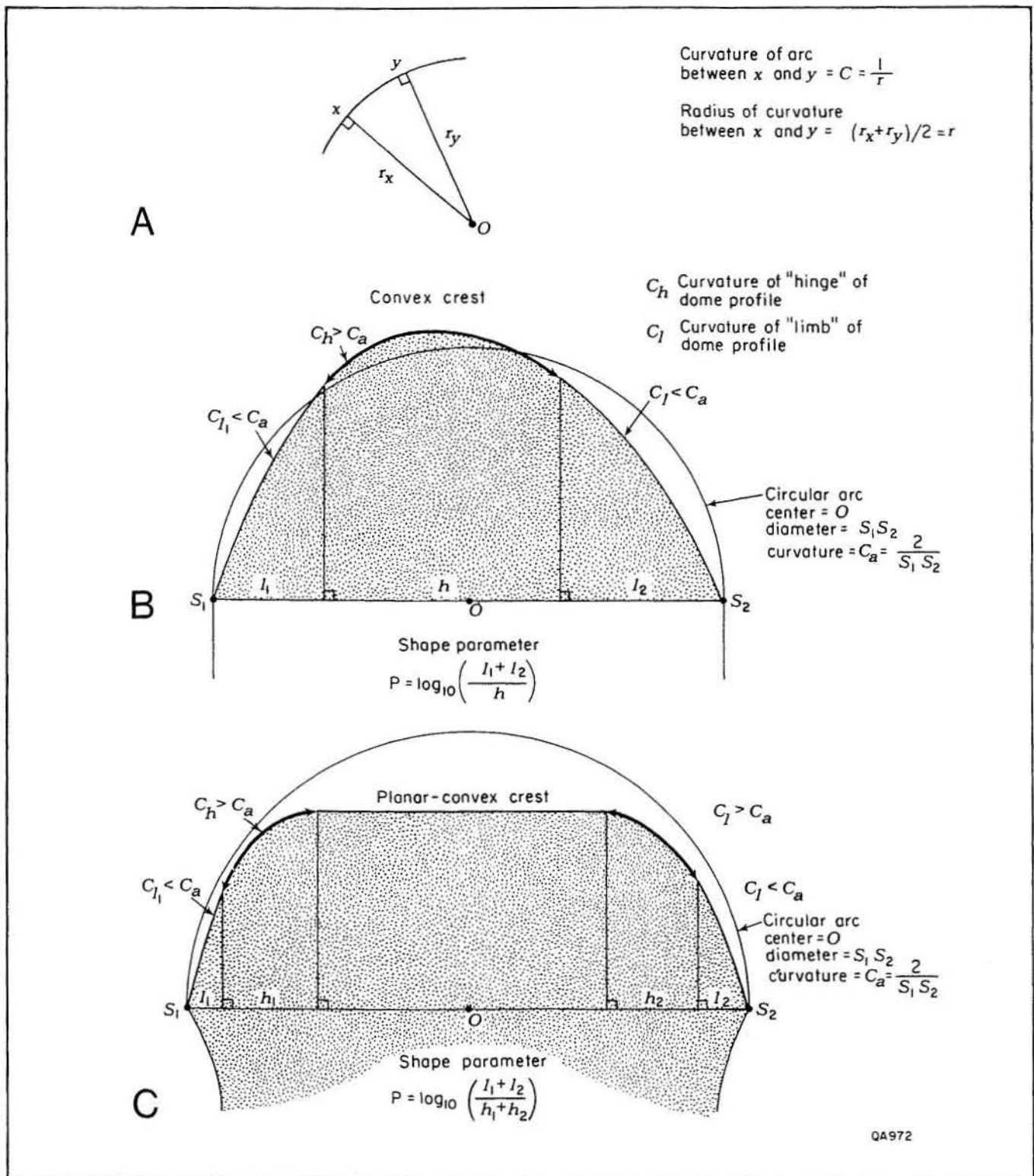

Figure 11. Derivation of a shape parameter to differentiate between diapir crests with straight or slightly curved sides and crests with strongly curved sides. (A) Calculation of curvature and radius of curvature between two points, x and y , on an arc (after Ramsay, 1967, fig. 7-7). (B) Calculation of the shape parameter in a cross section of a dome (stippled) having a nonplanar crest. The arc shown in heavy line has curvature greater than that of a circular arc and corresponds geometrically (not mechanically) to the hinge of a folded surface. (C) Calculation of the shape parameter in a cross section of a dome (stippled) having a crest with sloping sides and a planar, horizontal upper surface. The horizontal part is not involved in the calculation, and the shape parameter is independent of the percentage planar crest. Designating the shape parameter as a log allows values to vary symmetrically each side of zero.

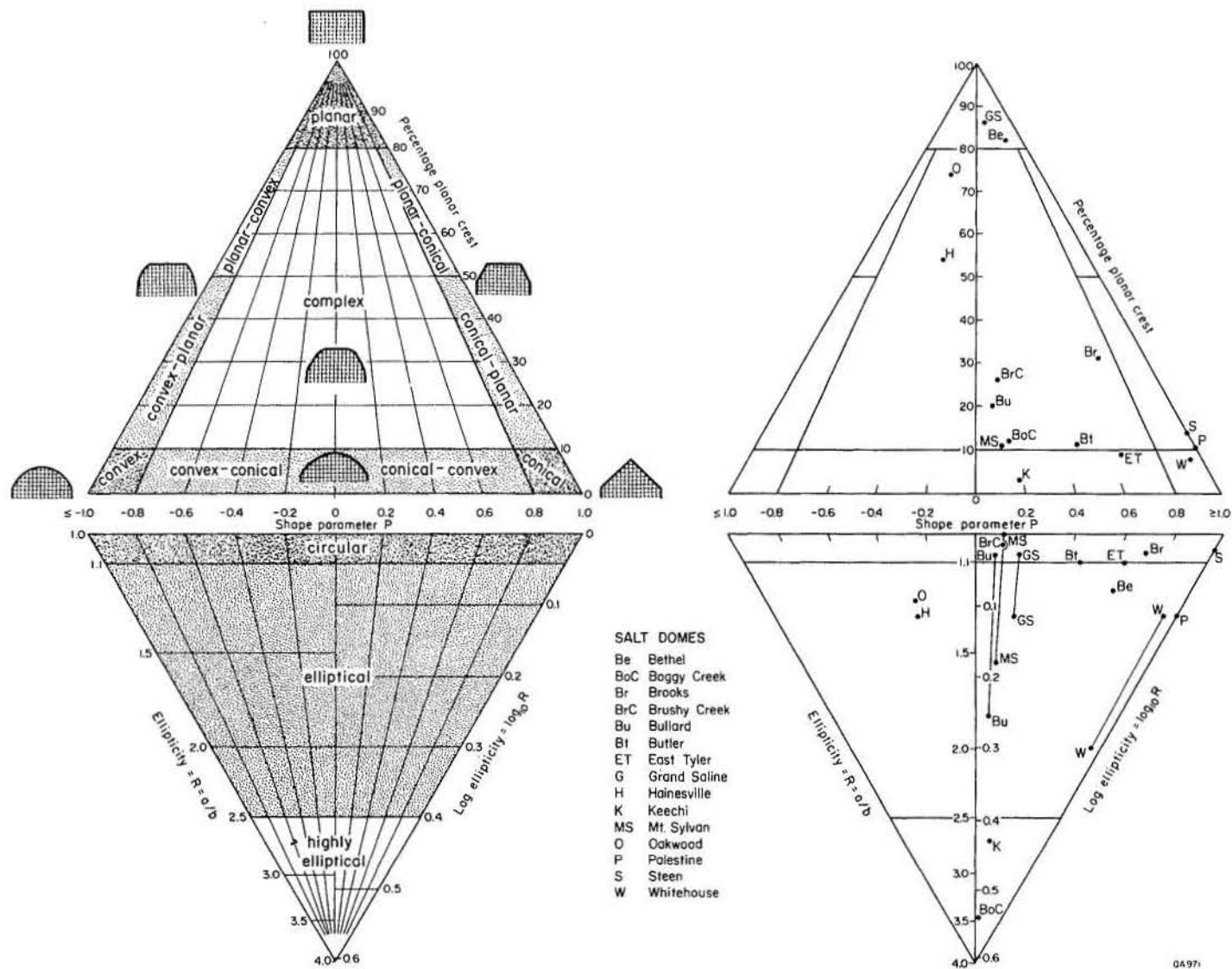

Figure 12. Quantitative classification of dome shape (left) and a plot of dome shapes from the East Texas Basin (right). Upper triangles plot percentage planar crest (measured in plan) against the shape parameter derived by the method in figure 11 (cross section). Lower triangles plot dome ellipticity (axial ratio) according to the scheme in figure 8 (measured in plan) against the shape parameter (measured in cross section). The log of ellipticity is used to allow better differentiation of near-circular diapirs. Diapirs represented by two end points and a tie line have horizontal sections that vary in shape with depth between the limits shown by the end points.

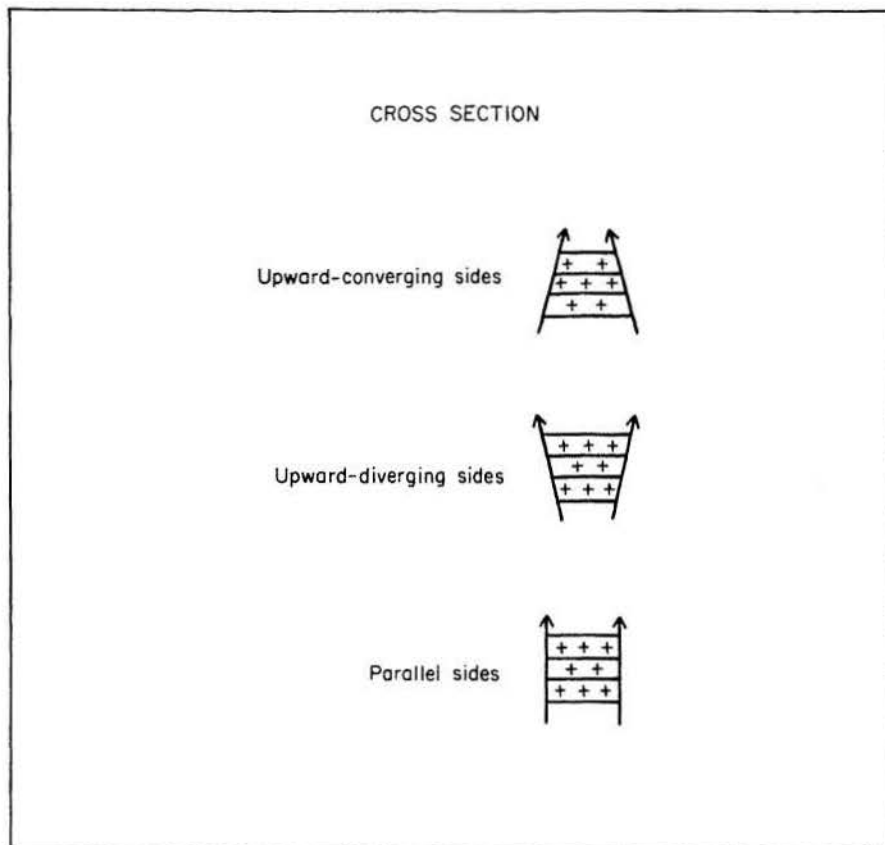

Figure 13. Classification of the slope of the sides of diapirs into three groups.

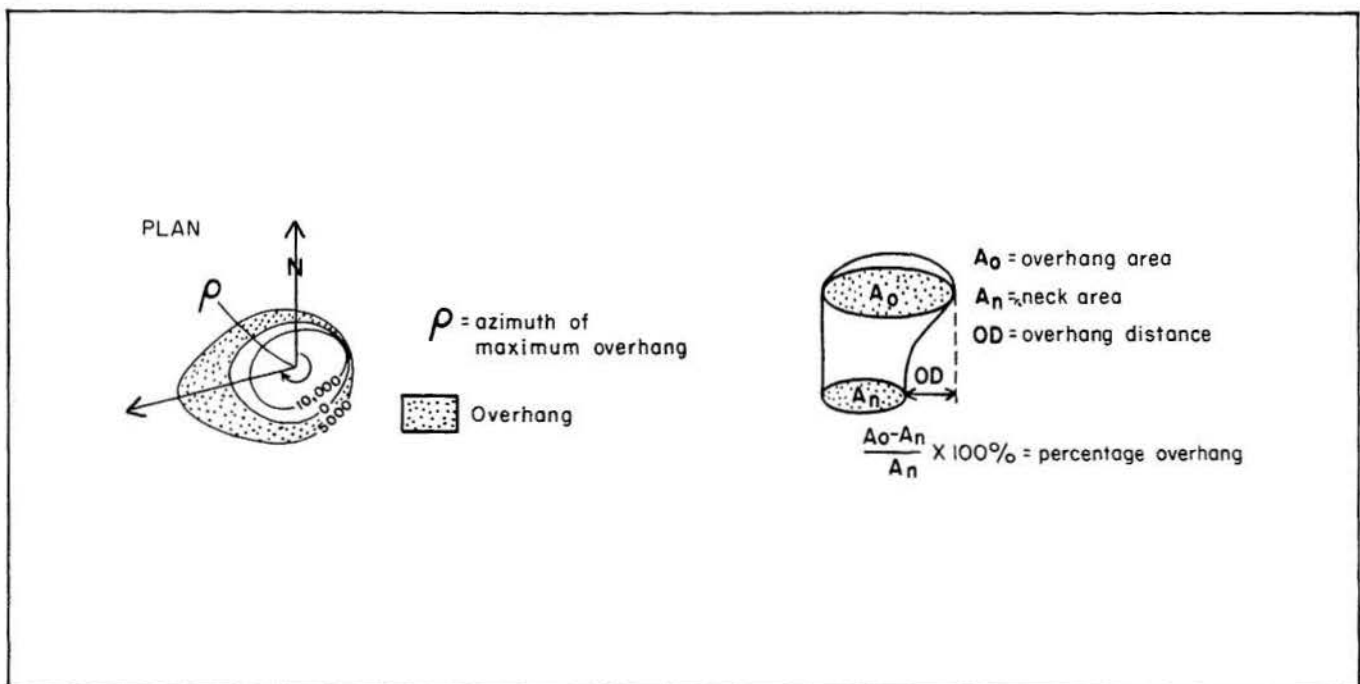

Figure 14. Parameters describing diapir overhang. Plan view on the left defines overhang and azimuth of maximum overhang on a structure-contour map on the salt upper surface. Contours are elevation below sea level. Oblique view on the right defines overhang area, neck area, overhang distance, and percentage overhang. Areas are measured by planimeter.

Dome Structure Adjacent to Salt Stock

Each salt dome includes both a central salt stock and a surrounding aureole of domed strata. The size of this deformation aureole is expressed by the size of the **drag zone** (fig. 15), which is the maximum distance between the two opposing **trough points** of the troughs directly adjacent to the diapir in cross section. The distance is measured at the level of the secondary peripheral sink (described in the section on growth history). The **rim syncline width** is defined as the maximum distance between the two opposing **crest points** in cross section (fig. 15). Although the limits of a fold are generally accepted to be the inflection points on its limbs (Ramsay, 1967, p. 347), our definition is more relevant in salt-dome studies because the crest line is easy to delineate as the outermost closed structure contour on a map of the deformed strata around the dome. The **axial trace** of a rim syncline connects the trough points in cross section or plan view along the deepest part of the rim syncline; in plan view, axial trace is synonymous with trough line. Rim synclines can flank or entirely surround a diapir.

Relative dips of the salt-stock contact and the surrounding strata are given in terms of two

parameters (fig. 16): **dihedral angle**, δ , and maximum **dip of strata**, Δ . Where the salt contact is vertical, $\delta = 90 - \Delta$, but elsewhere the two parameters have no fixed relationship. At deep levels (secondary peripheral sink), Δ is measured in the rim syncline beyond the zone of upward drag, where this angle is negative. At shallow levels, δ is measured in the zone of upward drag because the rim syncline is poorly developed at high levels.

The **dihedral angle** provides a useful guide to recognizing the presence of a ring fault along the stock contact (Smith and Reeve, 1970). Strata must be in contact with the salt either by means of a fault or by means of onlap. During onlapping deposition around an exposed salt plug, the **onlap angle** (equivalent to the dihedral angle where $\delta < 90$ degrees) must be equivalent to the topographic slope of the exposed salt plug. In sedimentation, generally, this onlap angle rarely exceeds 10 degrees because of erosion and lack of lateral support buttressing the exposed bedrock. In the case of aqueous deposition around a salt plug, the highly soluble nature of rock salt ensures that the onlapped salt surface commonly dips at less than 1 degree; thus the dihedral angle on

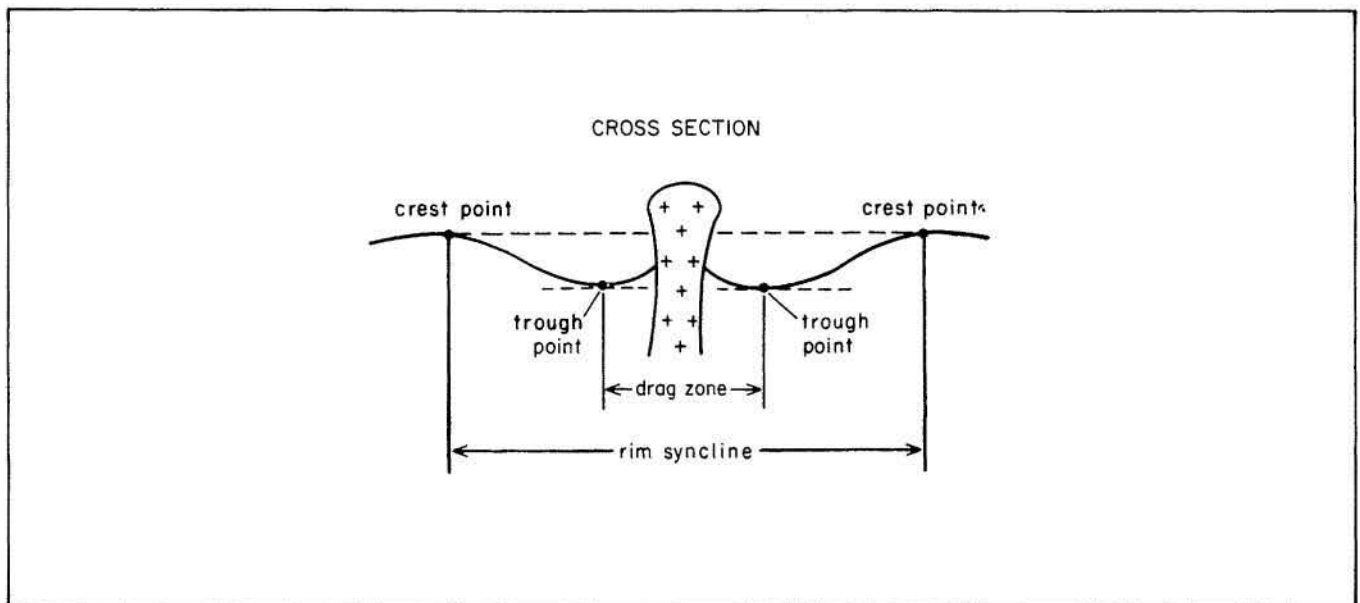

Figure 15. Definition of the size of a rim syncline and drag zone in cross section. Crest points and trough points correspond to the highest and lowest points on salt-related structures in cross section; crest lines and trough lines are the linear extensions of these points. In plan view, trough line is equivalent to axial trace.

onlapped salt is probably less than 1 degree and certainly less than 10 degrees. Dihedral angles of greater than 10 degrees are common between the salt contact and the surrounding strata and unequivocally indicate that a contact fault (probably circumferential) separates the salt from surrounding strata. Dihedral angles of less than 10 degrees can result from either onlap or low-angle faulting and therefore are equivocal as to the nature of the contact.

The **dip of the surrounding strata** is also recorded. Negative angles indicate that strata dip toward the dome; positive angles indicate that strata dip away from the dome (fig. 16). Strata dipping toward the dome indicate that the salt-withdrawal basin is subsiding faster than the regional subsidence rate because of vigorous diapirism. Conversely, strata dipping away from the diapir indicate that the rate of local salt withdrawal has declined so much that it is exceeded by the rate of uplift of strata overlying the rising salt plug. The level at which the surrounding strata have zero dip (outside the narrow aureole of upward drag) marks the

point where the rate of salt withdrawal in the local rim syncline has apparently declined to zero: here strata are subsiding at the regional rate only, so they do not deflect from regional dip. Strata of zero dip therefore mark the transition from the diapir stage to the postdiapir stage (growth stages of salt domes are described more fully in a later section). Post-diapiric salt stocks can still rise relative to surrounding strata even though they are no longer drawing salt from the source layer. The stocks elongate by thinning of their trunks, just as the tail of a viscous drop begins to thin before pinching off completely.

Faults associated with diapirs form as **crestal faults** over a salt stock, as **flank faults** adjacent to the stock, and as **ring faults** tangential to the stock along its contacts. Faults may form as single faults with **simple offset** or as groups of faults with the same sense of displacement, causing **multiple offset**. To aid in interpreting their origin, we also distinguish between **homothetic** and **antithetic faults** (fig. 17). Homothetic is synonymous with

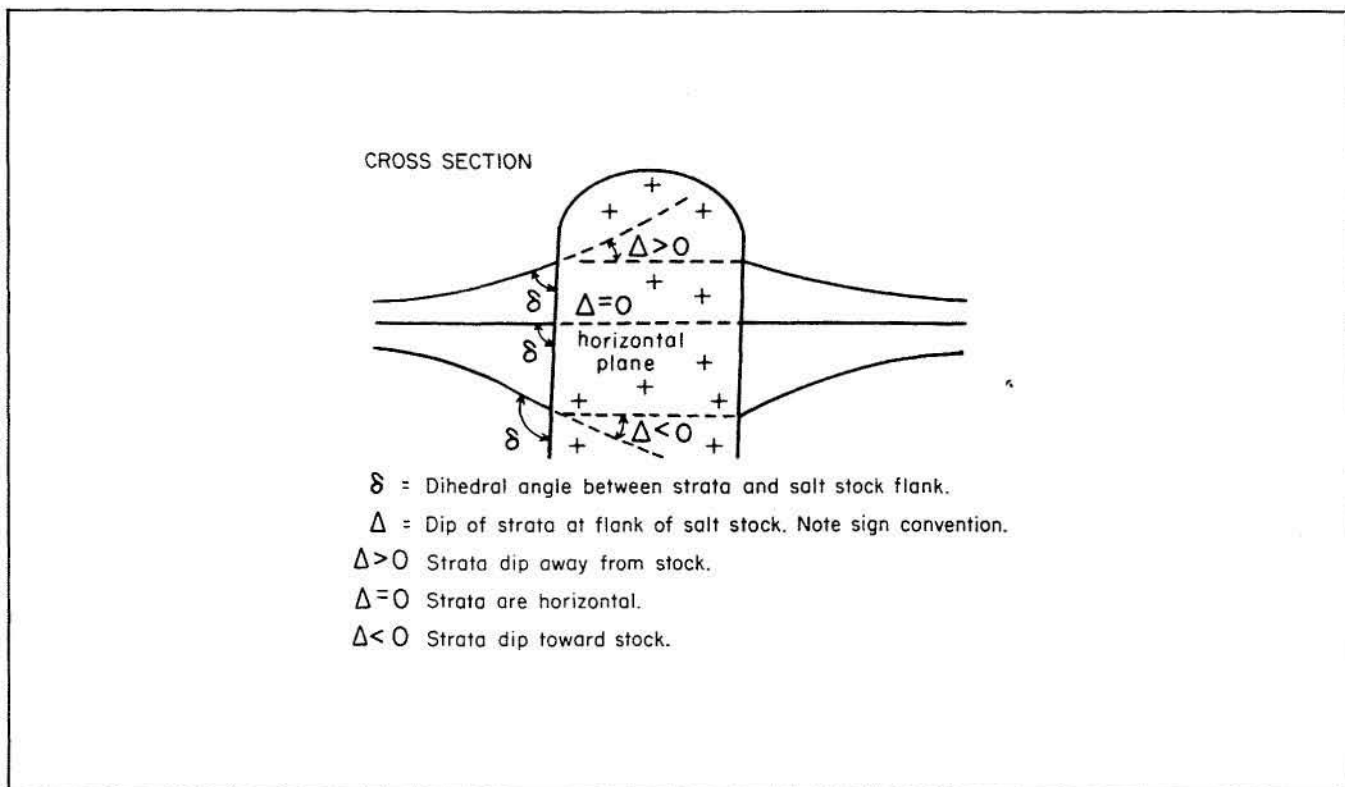

Figure 16. Definition of maximum dip of strata and the dihedral angle between strata and the salt-stock flank. Stratal dip provides clues to dome-growth stage, whereas the dihedral angle indicates whether a ring fault exists along the contact of the salt stock, as described in the text (p. 17-18).

synthetic but is less ambiguous because it avoids unrelated connotations of synthetic such as "combining elements" or "artificial" (Lotze, 1931). As did Dennis and Kelley (1980), we distinguish between homothetic and antithetic faults according to the original criteria proposed by Cloos (1928): antithetic faults result from leveling movements that reduce structural relief of major structures, whereas homothetic faults reinforce the structural relief. Neither type of fault is necessarily related to major faults. In the context of salt domes (fig. 17), distinguishing the two types of faults helps to interpret their

origins. For example, antithetic crestal faults indicate collapse of the strata that have been bowed upward by previous rise of the salt stock; the strata may have collapsed during dissolution of the salt crest. Conversely, homothetic crestal faults provide unequivocal evidence of the rise of the salt plug relative to surrounding strata; such faults not only allow extensional thinning but also promote rise of the overlying strata. On dome flanks, homothetic faults are likely to form in strata dipping toward the dome during diapir growth and pillow subsidence. For strata dipping away from the dome flanks, the formation of

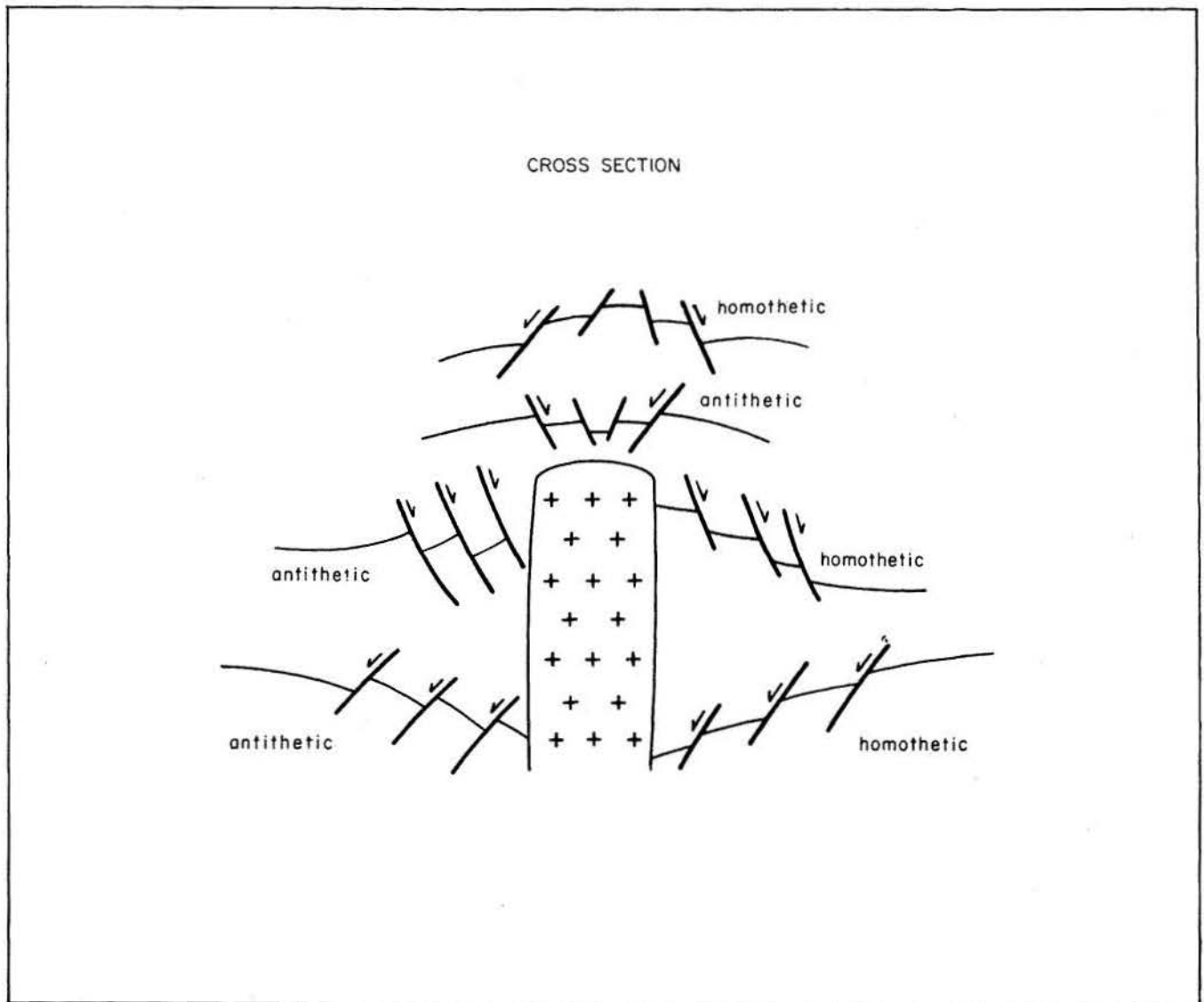

Figure 17. Classification of antithetic and homothetic (equivalent to synthetic) faults around salt stocks, based on Cloos (1928) and Dennis and Kelley (1980). Differentiation is based on whether the faults increase (homothetic) or reduce (antithetic) the structural relief induced by dome faulting.

homothetic or antithetic faults is controlled by the same processes as those described for the dome crest.

Growth History

The **age of the youngest faulted strata** is recorded to provide a maximum age of the most recent episode of faulting. This information is relevant to assessing the structural stability of a salt dome being considered as a repository for the isolation of nuclear or other toxic waste. The **age of the oldest strata at the surface** above a dome gives a measure of the degree of uplift by folding and faulting caused by dome growth. Map patterns indicative of doming by upwarping or upfaulting show exposures of anomalously old strata above domes and are indicated in the tables by the phrase "stratigraphic evidence of doming at surface."

Seni and Jackson (1983a, 1983b; 1984) demonstrated that the salt domes of the East Texas Basin evolved through the three growth stages first described by Trusheim (1960). The **pillow stage** is characterized by (1) thinning of adjacent strata toward the salt stock; (2) minor thickening into relatively distant primary peripheral sinks filling the rim syncline; and (3) shallower water, marine sediments or muddier fluvial sediments over the pillow crest (fig. 18A). The **diapir stage** is characterized by major thickening of adjacent strata in a secondary peripheral sink, and probably by the same lithostratigraphic variations over the crest of the salt stock as observed in the pillow stage, although such strata are rarely preserved because subsequent rise of the salt plug exposes its overburden to erosion (fig. 18B). The **postdiapir stage** is characterized by tertiary peripheral sinks that form adjacent to the diapir (fig. 18C). In the maps and tables, we have arbitrarily differentiated secondary from tertiary peripheral sinks at a value of 50 percent thickening above regional thicknesses; secondary sinks are thicker than tertiary sinks and are generally of broader extent. An alternative criterion, which is more soundly

Figure 18. Geometry and lithofacies characteristic of the three stages of salt-dome growth: (A) pillow stage, (B) diapir stage, and (C) postdiapir stage. (From Seni and Jackson, 1983a, 1984).

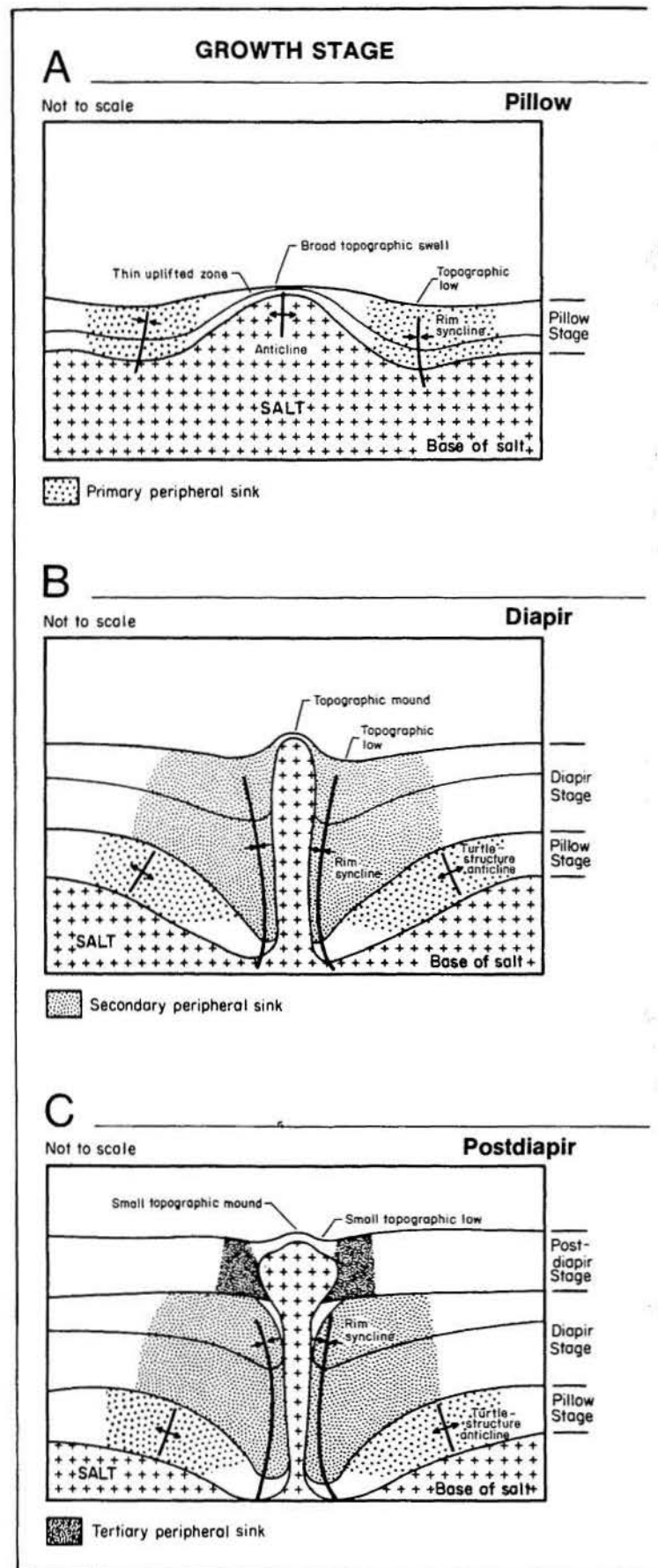

UPLIFTED AREA**WITHDRAWAL BASIN****Geometry**

Sediments above pillow are thin over broad, equidimensional to elongate area. Maximum thinning over crest. Area ranges from 100 to 400 km² (40 to 150 mi²), depending on size of pillow. Percent thinning, 10 to 100%.

Facies

Thin, sand-poor, fluvial-deltaic deposits over crest of pillow include interchannel and interdeltic facies. Erosion common. Carbonate deposits on crest would include reef, reef-associated, and high-energy facies.

Geometry

Sediments are thickened in broad to elongate primary peripheral sink, generally located on updip side of salt pillow. Axial trace of sink parallels axial trace of elongate uplift; axial traces are generally 5 to 20 km (3 to 12 mi) apart. Area of sink ranges up to 300 km² (120 mi²), depending on size of pillow. Percent thickening, 10 to 30%. Recognition of primary peripheral sink may be hindered by interference of nearby salt structures.

Facies

Thick, sand-rich, fluvial-deltaic deposits in primary peripheral sink include channel axes and deltaic depocenters. Aggradation common in topographically low area of sink. Carbonate deposits in sink would include low-energy facies caused by increase in water depth.

Geometry

Strata are largely absent above dome. An area ranging from 8 to 50 km² (3 to 20 mi²) around diapir is thinned; area depends on size and dip on flanks of dome.

Facies

Facies immediately over dome crest are not preserved because of piercing by diapir of all but the youngest strata. Sand bodies commonly pinch out against dome flanks.

Geometry

Sediments are thickened from 50 to 215% in secondary peripheral sink. Area of sink ranges up to 1,000 km² (390 mi²) in extent. Sink is equidimensional to elongate and preferentially surrounds single or multiple domes.

Facies

Expanded section of marine facies, including limestones, chinks, and mudstones, dominates. Generally sink is filled with deeper water, low-energy facies caused by increased water depth. Elevated saddles between withdrawal basins are favored sites of reef growth and accumulated high-energy carbonate deposits.

Geometry

Strata are thin or absent in an area ranging from 10 to 50 km² (4 to 20 mi²) over crest and adjacent to dome; area depends on size of dome and dip of flanks.

Facies

Facies and strata over crest of dome are not preserved in cases of complete piercement. Modern analogs have interchannel and interdeltic facies in uplifted area. Mounds above dome include thin sands. Carbonate strata would include reef or high-energy deposits; erosion common.

Geometry

Area of tertiary peripheral sink ranges from 20 to 200 km² (8 to 80 mi²). Sediments are thickened up to 50%, commonly by > 30 m (100 ft). Axial trace of elongate to equidimensional sink surrounds or flanks a single dome, or connects a series of domes.

Facies

Modern analogs have channel axes in sink. Aggradation of thick sands common in subsiding sink. Carbonate strata would include low-energy facies.

related to the mechanisms forming peripheral sinks, is that of stratal dip (fig. 16). As previously discussed, the level at which strata are horizontal ($\Delta = 0$ degrees) beyond the immediate vicinity of the salt stock where strata are dragged up by diapirism marks the end of vigorous diapirism in the sedimentary record. This is an appropriate evolutionary stage to mark the transition from diapir growth to postdiapir growth.

For each growth stage we estimated the **age of initiation** and the **age of cessation**, from which the **duration of growth** can be calculated. This estimation is only possible in the youngest domes, termed group 3 domes by Seni and Jackson (1983a, 1983b; 1984). The age of cessation of diapirism can be fixed for the next oldest group 2 domes, but the age of initiation generally cannot, for this age predates the oldest units studied by means of regional well control. In the case of the oldest domes, termed group 1 domes, diapirism had already ceased when the Glen Rose Subgroup was deposited. This subgroup is the oldest unit studied in detail from borehole data on a regional scale in the East Texas Basin. An exception is Oakwood Dome, the early history of which has been determined using seismic profiles of strata that extend below the depths commonly drilled.

Because the peripheral sink migrates toward the dome, the distance from the center of the dome to the developing rim syncline decreases upward. The **axial trace** of the rim syncline corresponds to the thickest part of the peripheral sink at the time when a particular unit is deposited around a salt stock. The **distance of the axial trace from the center of the dome** is significant because the variation in this distance enables the migration of the peripheral sinks to be tracked through stratigraphic time. This migration provides a measure of the rate at which a salt pillow deflates because salt is withdrawn from it to

feed a rising diapir in the center of the salt structure. The **age of migration of the sink to the salt-stock contact** marks the point at which salt withdrawal into a growing diapir from the surrounding salt-pillow reservoir had almost ceased. Further upward growth of the salt stock is inferred to have been caused by thinning of the trunk of the diapir because little or no salt was added to the base of the diapir. Most of the East Texas salt stocks are inferred to have reached this mature stage of growth. About half the stocks (Bethel, Brooks, East Tyler, Hainesville, Mount Sylvan, and Steen Domes) began to elongate by trunk thinning in the diapiric stage; the other half (Butler, Grand Saline, Keechi, Oakwood, and Palestine Domes) in the postdiapiric stage. All the second half are in group 1 (fig. 6), the oldest domes recognized by Seni and Jackson (1983a, 1983b; 1984). This grouping suggests that more salt was available in the reservoirs below the diapirs in the early stages of basin evolution than in the later stage, an observation that is in agreement with studies on the rate of salt loss in the basin (Seni and Jackson, in preparation).

Dome-related unconformities are angular unconformities centered on salt domes, exemplified by Hainesville Dome (fig. 56). These unconformities result from erosion of strata uplifted by the dome and subsequently buried. The largest unconformities are related to erosion of strata above a broad salt pillow, which breached the cover and exposed the salt to erosion, extrusion, or dissolution. This erosional breaching has an important bearing on the growth of a dome, for salt loss through the exposed orifice and salt withdrawal from the surrounding pillow were greatly accelerated as diapirism began (Loocke, 1978; Turk, Kehle and Associates, 1978; Seni and Jackson, 1983a, 1983b; 1984). Unconformities record these periods of erosional breaching and rapid growth.

Structural and Hydrologic Stability

The maximum age of the **youngest deformation** resulting from salt-dome growth corresponds to the age of the youngest deformed sedimentary unit. This deformation includes folding, faulting, and thickness changes that are geometrically related to the underlying salt dome. Data on the age of

deformation are relevant to assessing the structural stability of a salt dome being considered as a potential repository for nuclear wastes.

Also relevant to the structural stability of a dome is **subsidence** of strata above a dome, usually attributed to subsurface dissolution of

salt by ground water or to brining operations during salt mining. Evidence of subsidence includes deformed overlying strata, drainage patterns over the dome, or saline discharge near buried salt stocks. Based on these criteria, an overall assessment of the evidence of subsidence of the crest of the dome can be given as **present**, **absent**, or **equivocal**. The presence of antithetic faults or of local synclines in strata over the crest of a salt stock constitutes evidence of subsidence. If subsidence affects the topography, local drainage systems may reflect this influence. Drainage systems sensitive to dome subsidence were proposed by Collins and others (1981) and have been modified here into a system having four ideal types (fig. 19). Two types are radial: **centrifugal drainage** occurs

over domes rising faster than the overburdens are being eroded, so subsidence is not apparent; **centripetal drainage** provides evidence of collapse over the dome crest. **Subcentripetal drainage** suggests subsidence but is equivocal evidence. **Transverse drainage** indicates that any rise or subsidence of the dome is negligible compared with the rate of regional uplift or subsidence and the rate of stream incision or aggradation. None of the 15 shallow domes in the East Texas Basin has centrifugal drainage, unlike many of the actively growing Gulf Coast domes. Additional evidence of subsurface dissolution of a salt stock includes presence of **sinkholes**, ponds, or natural lakes above the domes, or **surface salines**, such as saline springs, streams, lakes, or salt crusts.

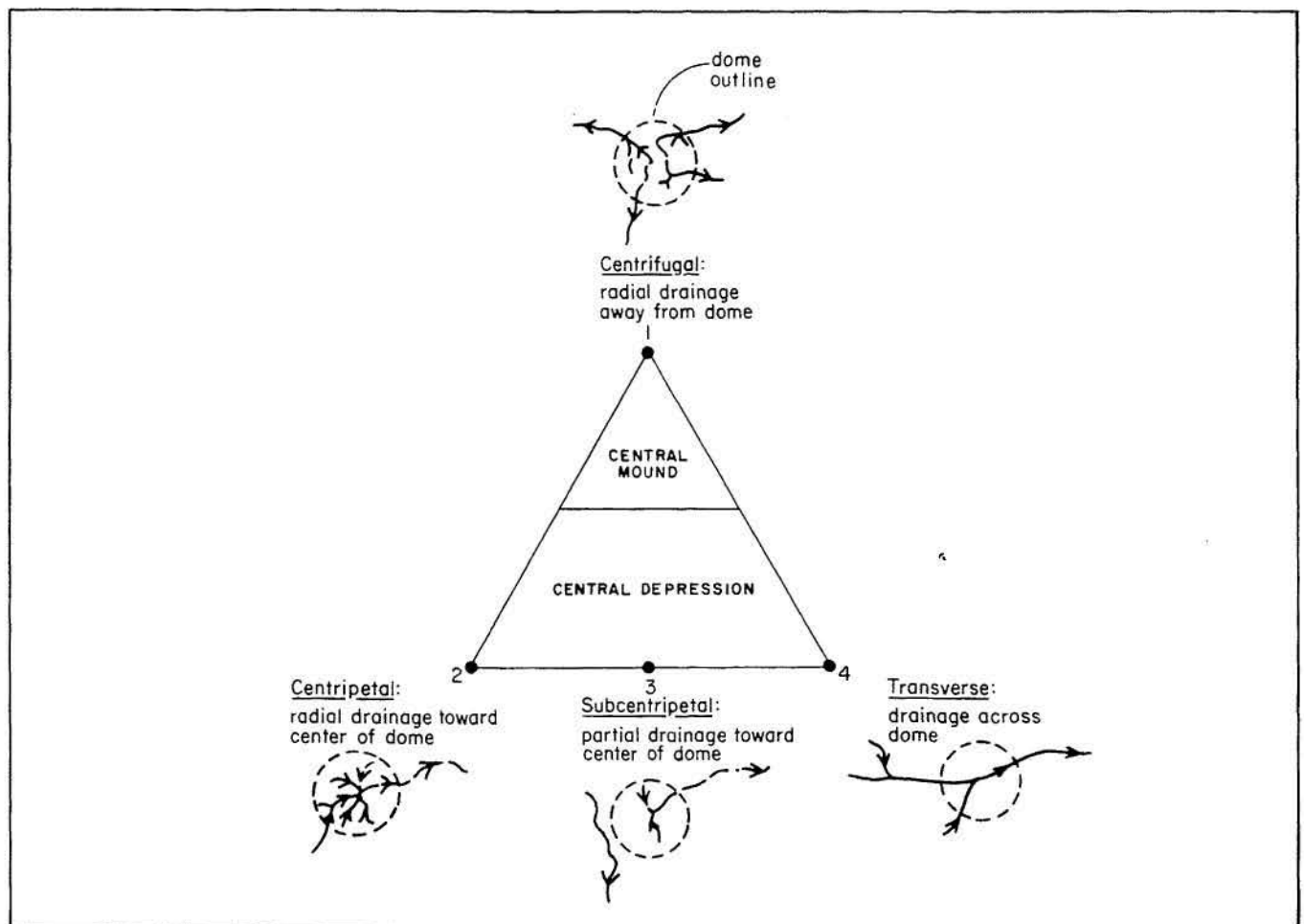

Figure 19. Qualitative classification of drainage systems above domes into four ideal types as a guide to relative movement of the land surface above. Type 1 is characteristic of domes undergoing uplift faster than the regional rate of erosion. Types 2 and 3 develop over domes with subsiding crests. Type 4 is characteristic of static domes having negligible influence on surface processes.

Resources

Hydrocarbon production histories from producing salt domes are listed, based on data through 1978 from the files of the Railroad Commission of Texas. Data include the **number of producing wells**, the **current and cumulative total production**, the **stratigraphic reservoir unit**, and the types of **traps**. **Salt mines** are

noted, as are **storage facilities** for petroleum and derived products such as liquefied petroleum gas (LPG) within mined cavities in salt stocks. Further details on petroleum occurrences in the domes of the East Texas Basin have been synthesized by Wood and Giles (1982) and Galloway and others (1983).

SIGNIFICANCE FOR EXPLORATION

This summary of the 15 shallow salt domes in the East Texas Basin can be used by the petroleum industry and the mining industry as a guide for exploration and for estimation of storage capacity. Shallow, diapir-related petroleum reservoirs in the East Texas Basin have thus far been meager compared with similar geologic environments in the Texas - Louisiana Gulf Coast. Excluding the great Woodbine unconformity trap of East Texas, 98 percent of the oil and 85 percent of the gas from the diapir

province in the center of the basin originate from the broad anticlinal structures overlying salt pillows and turtle structures (Wood and Giles, 1982). These salt-related anticlinal structures are commonly deep and are likely to contain substantial undiscovered reserves in the Jurassic units. A thorough understanding of diapir growth history is necessary to explore for turtle structures, the distribution of which is controlled by the growth of diapirs, in the East Texas Basin.

ATLAS OF SALT DOMES

DOME NAME: BETHEL

LOCATION:

NW Anderson Co.
31° 53' 23" N; 96° 54' 54" W

RESIDUAL GRAVITY EXPRESSION:

-88 G units

DEPTH:

Depth to Cap Rock:

1,440 ft (439 m)

Depth to Salt Stock:

1,600 ft (488 m)

Depth to Top of Louann Salt (approximate):

20,000 ft (6,100 m)

ORIENTATION AND MAXIMUM LATERAL DIMENSIONS OF SALT STOCK:

Major Axis:

Length:

2.3 mi (3.7 km)

Orientation:

015°

Minor Axis:

Length:

1.9 mi (3.0 km)

Area:

3.4 mi² (8.7 km²)

Area of Planar Crest:

2.8 mi² (7.2 km²)

Percentage Planar Crest:

82%

SHAPE OF SALT STOCK:

General:

Piercement stock

Plan:

Elliptical (axial ratio = 1.2)

Cross Section:

Axis:

Vertical

Approximate Overall Symmetry:

Orthorhombic

Crest:

Planar

Sides:

Upward diverging from -5,000 ft to -2,500 ft (-1,524 m to -762 m); upward converging above -2,500 ft (-762 m); deepest data -5,000 ft (-1,524 m)

Overhang:

Well developed, circumdomal, symmetrical, elevation -2,500 ft (-762 m); maximum lateral overhang 2,100 ft (640 m) on S flank; percentage overhang 63%

CAP ROCK:

Maximum Stratigraphic Thickness:

493 ft (150 m) in center, thins toward flanks of dome

Minimum Stratigraphic Thickness:

62 ft (19 m)

Composition:

Calcite, anhydrite

GEOMETRY OF ADJACENT STRATA:

Lateral Extent of Rim Syncline:

48,000 ft (14,600 m)

Lateral Extent of Drag Zone:

12,000 ft (3,650 m)

Vertical Variation in Maximum Dip of Strata:

$\Delta = -2^\circ$ to -6° from -10,000 ft (-3,000 m) (Travis Peak) to -1,000 ft (-305 m) (Wilcox)

$\Delta = 0^\circ$ at -1,000 ft (-305 m) (Wilcox)

$\Delta = +8^\circ$ above -1,000 ft (-305 m) (Claiborne)

Angle Between Salt and Surrounding Strata:

$\delta \approx 90^\circ$ to 130° at -9,300 ft (-2,835 m) (Glen Rose) to -1,970 ft (-600 m) (Midway)

$\delta = 20^\circ$ at -1,300 ft (-396 m) (Midway)

$\delta = 0^\circ$ at -1,000 ft (-305 m) (Wilcox)

Contact fault below -1,000 ft (-305 m)

Oldest Planar Overburden:

Claiborne Group

BETHEL DOME (continued)

FAULTING OF ADJACENT STRATA:

Faults at Flanks:

On both sides, single offset, normal, antithetic, down-to-dome faults. NW side, Woodbine and Eagle Ford age (growth). SE side, Paluxy age

Crestal Faults:

Single offset, normal, antithetic, down-to-dome fault on NW side

Youngest Faulted Strata:

Claiborne Group

Oldest Strata at Surface:

Claiborne Group: no stratigraphic evidence of doming at surface

GROWTH HISTORY:

PRIMARY PERIPHERAL SINK:

Age of Initiation:

Pre-110 Ma

Age of Cessation:

90 Ma

Duration of Growth:

At least 20 Ma

Distance of Axial Trace from Center of Dome:

6 mi (10 km)

SECONDARY PERIPHERAL SINK:

Age of Initiation:

90 Ma

Age of Cessation:

50 Ma

TERTIARY PERIPHERAL SINK:

Age of Initiation:

50 Ma

Age of Cessation:

Post-50 Ma

AGE OF MIGRATION OF SINK TO SALT-STOCK CONTACT:

70 Ma

DOME-RELATED UNCONFORMITIES:

None recognized

Evidence of Extrusion and Erosion of Salt:

None recognized

YOUNGEST DEFORMATION:

Fault in Wilcox Group

EVIDENCE OF SUBSIDENCE:

Absent

Configuration of Overburden Strata:

Flat-lying Claiborne Group

Drainage System:

Type 4, supradomal depression, transverse drainage

Sinkholes:

None

Surface Salines:

None

RESOURCES AND USES:

HYDROCARBONS:

2 fields: Bethel, East Bethel Dome

Number of Producing Wells:

Current: ?

Total: ?

Production:

Current

Total

} see chart on next page

Stratigraphic Reservoir:

Woodbine, Rodessa, Pettet (Bethel Field)

Rodessa, Pettet (East Bethel Dome Field)

Traps:

Beneath overhang (Woodbine-Bethel Field); flank fault downthrown toward dome (Rodessa, Pettet-East Bethel Field)

ROCK SALT:

Not mined

SULFUR:

None

GAS STORAGE:

3 wells for natural gas storage

BETHEL DOME (continued)

	Current oil production (bbl)	Current gas production (Mcf)	Total oil production (bbl)	Total gas production (Mcf)
Bethel Field:				
Woodbine	0	10,354	1,107,513	2,285,173
Rodessa	0	908,437	0	59,118,816
Pettet	0	639,525	0	8,796,870
East Bethel Dome Field:				
Rodessa	0	357,761	45,740	35,781,825
Pettet	10,957	0	80,062	4,564,377

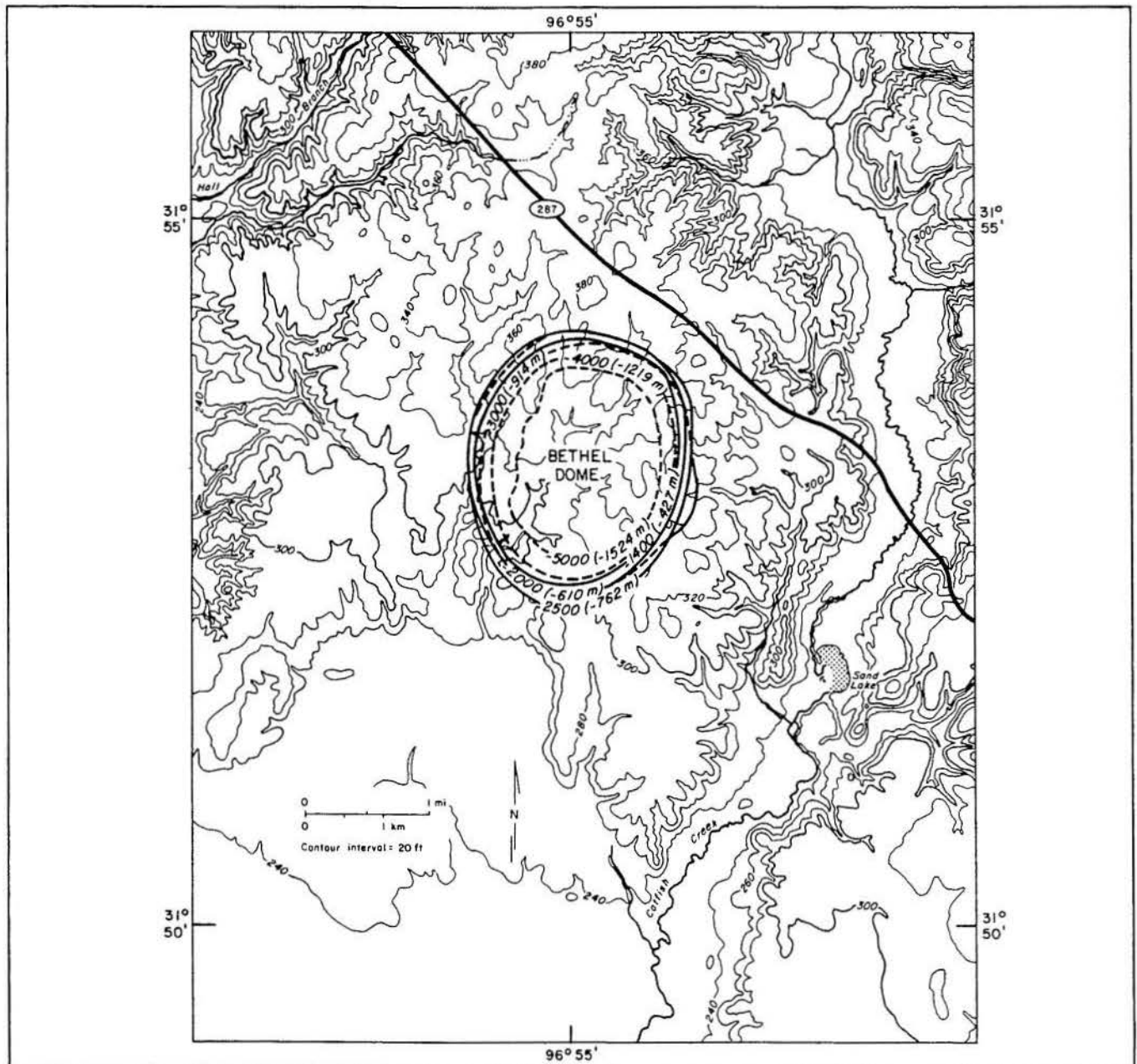

Figure 20. Map showing shape, location, topography, and drainage system of Bethel Dome (salt structure contours from Giles, 1980).

BETHEL DOME (continued)

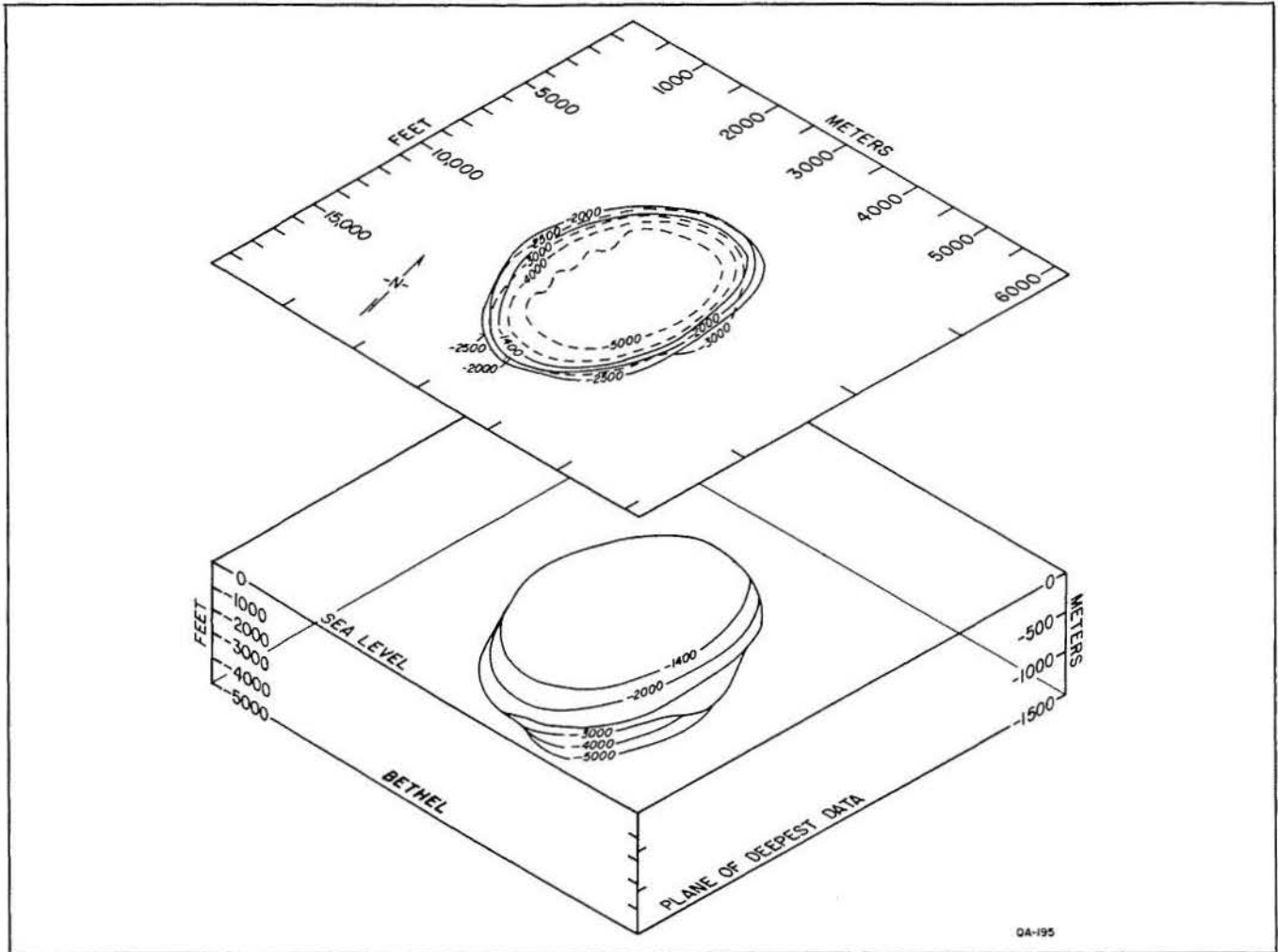

Figure 21. Isometric block diagram of Bethel salt stock.

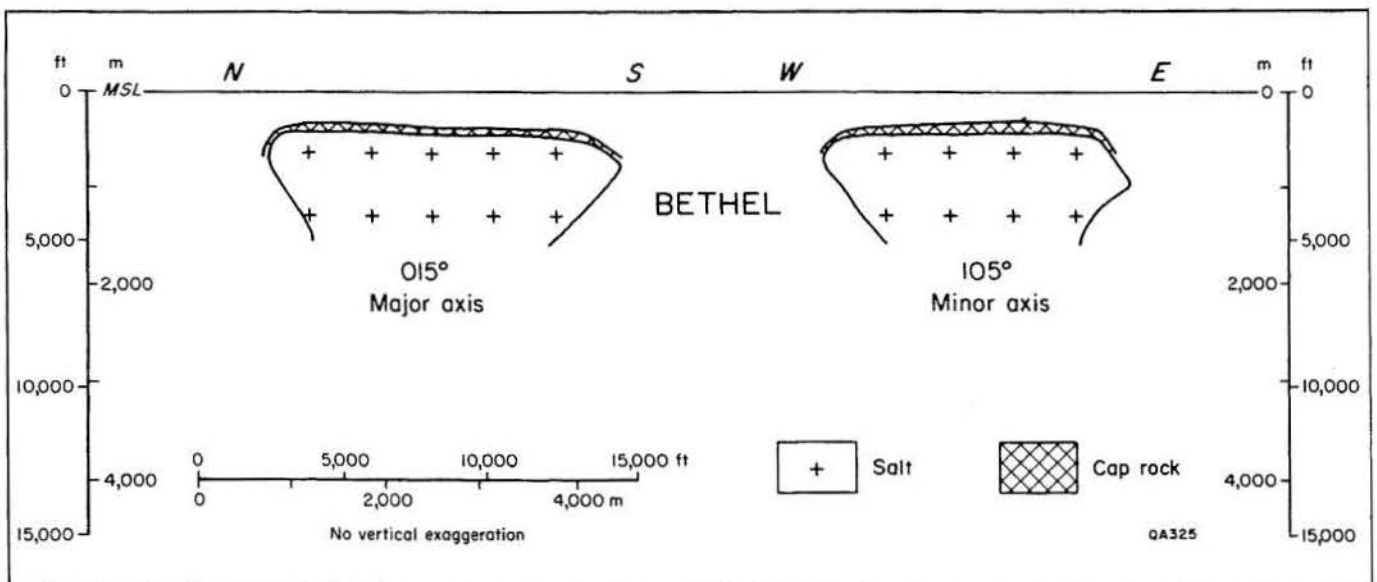

Figure 22. Orthogonal cross sections through major and minor axes of Bethel salt stock.

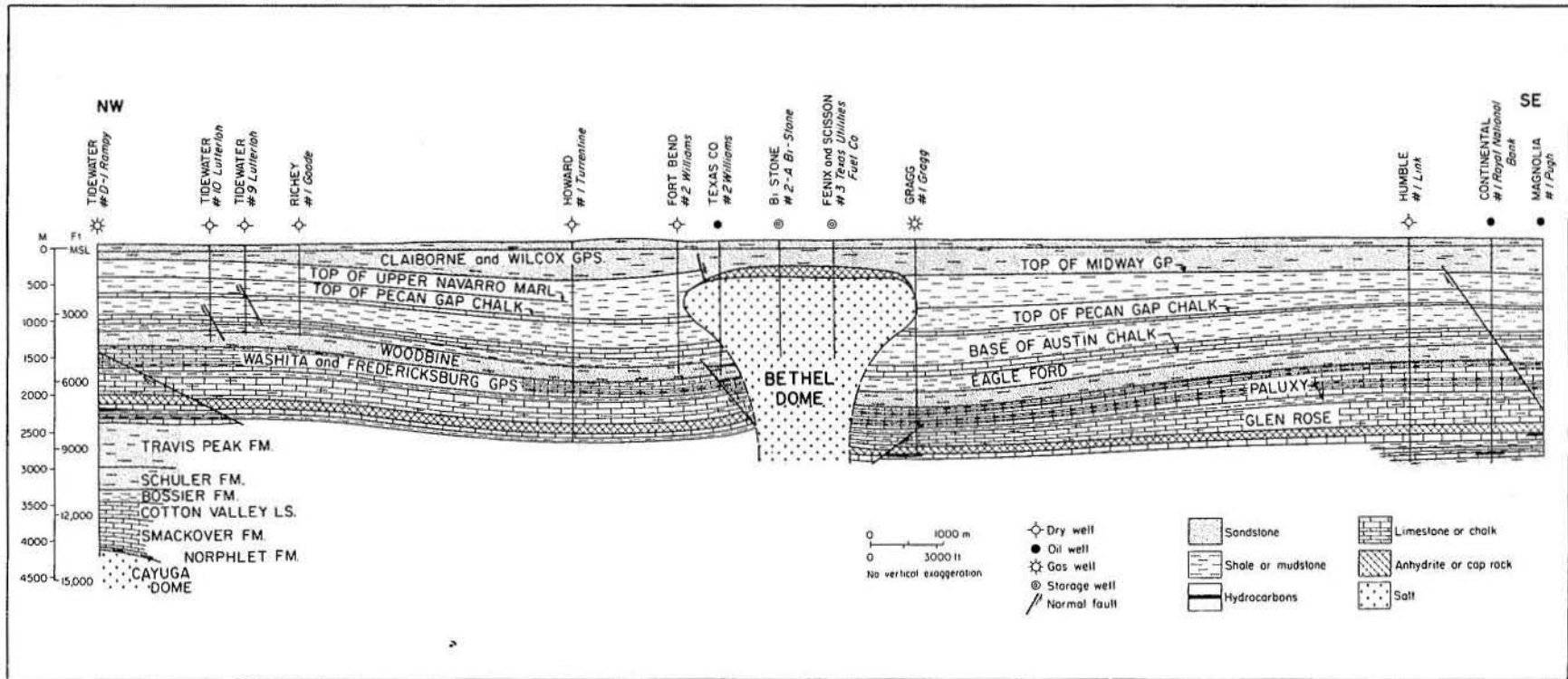

Figure 23. Structural cross section through Bethel Dome (Wood and Giles, 1982).

BETHEL DOME (continued)

DOME NAME: BOGGY CREEK

LOCATION:

NE Anderson Co., NW Cherokee Co.
31° 58' 07" N; 95° 26' 26" W

RESIDUAL GRAVITY EXPRESSION:

-108 G units

DEPTH:

Depth to Cap Rock:

1,692 ft (516 m)

Depth to Salt Stock:

1,829 ft (557 m)

Depth to Top of Louann Salt (approximate):

22,000 ft (6,700 m)

ORIENTATION AND MAXIMUM LATERAL DIMENSIONS OF SALT STOCK:

Major Axis:

Length:

> 9.0 mi (> 14.4 km)

Orientation:

035°

Minor Axis:

Length:

> 2.5 mi (> 4.0 km)

Area:

> 19.5 mi² (> 49.9 km²)

Area of Planar Crest:

2.3 mi² (5.9 km²)

Percentage Planar Crest:

12%

SHAPE OF SALT STOCK:

General:

Elongated piercement stock

Plan:

Highly elliptical (axial ratio = 3.5),
slightly sinuous

Cross Section:

Axis:

Axial plunge 83°; tilt direction 013°;
tilt distance 1,056 ft (322 m)

Approximate Overall Symmetry:

Triclinic

Crest:

Complex, crestline depression near S end

Sides:

Upward converging above -10,000 ft
(-3,048 m); deepest data -10,000 ft
(-3,048 m)

Overhang:

None recognized above -10,000 ft (-3,048 m)

CAP ROCK:

Maximum Stratigraphic Thickness:

123 ft (37 m) on upper flanks of dome, absent
on dome crest

Minimum Stratigraphic Thickness:

14 ft (4 m)

Composition:

Anhydrite, calcite

GEOMETRY OF ADJACENT STRATA:

Lateral Extent of Drag Zone:

15,000 ft (4,570 m)

Vertical Variation in Maximum Dip of Strata:

$\Delta = 0^\circ$ at -10,000 ft (-3,048 m)

(Glen Rose)

$\Delta = +48^\circ$ at -5,000 ft (-1,524 m) (Woodbine)

$\Delta = +15^\circ$ at -1,500 ft (-457 m) (Wilcox)

Angle Between Salt and Surrounding Strata:

$\delta = 60^\circ$ at -9,000 ft (-2,743 m)

(Glen Rose)

$\delta = 15^\circ$ to 0° from -3,000 ft (-914 m)

(Woodbine) to crest

Contact fault below Upper Washita Group

Oldest Planar Overburden:

Quaternary

FAULTING OF ADJACENT STRATA:

Faults at Flanks:

Graben to SE, faulted in Taylor time

Crestal Faults:

Antithetic, normal, down-to-dome, simple
offset in Navarro time

Youngest Faulted Strata:

Navarro Group

Oldest Strata at Surface:

Wilcox Group: no stratigraphic evidence of
doming at surface

BOGGY CREEK DOME (continued)

GROWTH HISTORY:

PRIMARY PERIPHERAL SINK:

Age of Initiation:

Pre-110 Ma

Age of Cessation:

Pre-110 Ma

Duration of Growth:

Unknown

Distance of Axial Trace from Center of Dome:

4 to 6 mi (6 to 10 km)

SECONDARY PERIPHERAL SINK:

Age of Initiation:

Pre-110 Ma

Age of Cessation:

100 Ma

TERTIARY PERIPHERAL SINK:

Age of Initiation:

100 Ma

Age of Cessation:

50 Ma

AGE OF MIGRATION OF SINK TO SALT-STOCK CONTACT:

Sink has not migrated to salt stock

DOME-RELATED UNCONFORMITIES:

Evidence of Extrusion and Erosion of Salt:

None recognized

YOUNGEST DEFORMATION:

Fault in upper Navarro Marl

EVIDENCE OF SUBSIDENCE:

Absent

Configuration of Overburden Strata:

Claiborne strata not present over dome crest;
Quaternary alluvium present over dome crest

Drainage System:

Type 4, central supradomal depression,
transverse drainage

Sinkholes:

None

Surface Salines:

None

RESOURCES AND USES:

HYDROCARBONS:

Number of Producing Wells:

Current: ?

Total: ?

Production:

Current:

12,877 bbls - Woodbine; 222 bbls - Wilcox

Total:

6,751,841 bbls - Woodbine; 8,888 bbls -
Wilcox; 292,718 Mcf (cumulative to 1980) -
Woodbine

Stratigraphic Reservoir:

Woodbine Group; Wilcox Group

Traps:

Truncation by side of salt stock; supradomal
fault or anticline (Wilcox)

BRINE:

None

SULFUR:

None

GAS STORAGE:

None

BOGGY CREEK DOME (continued)

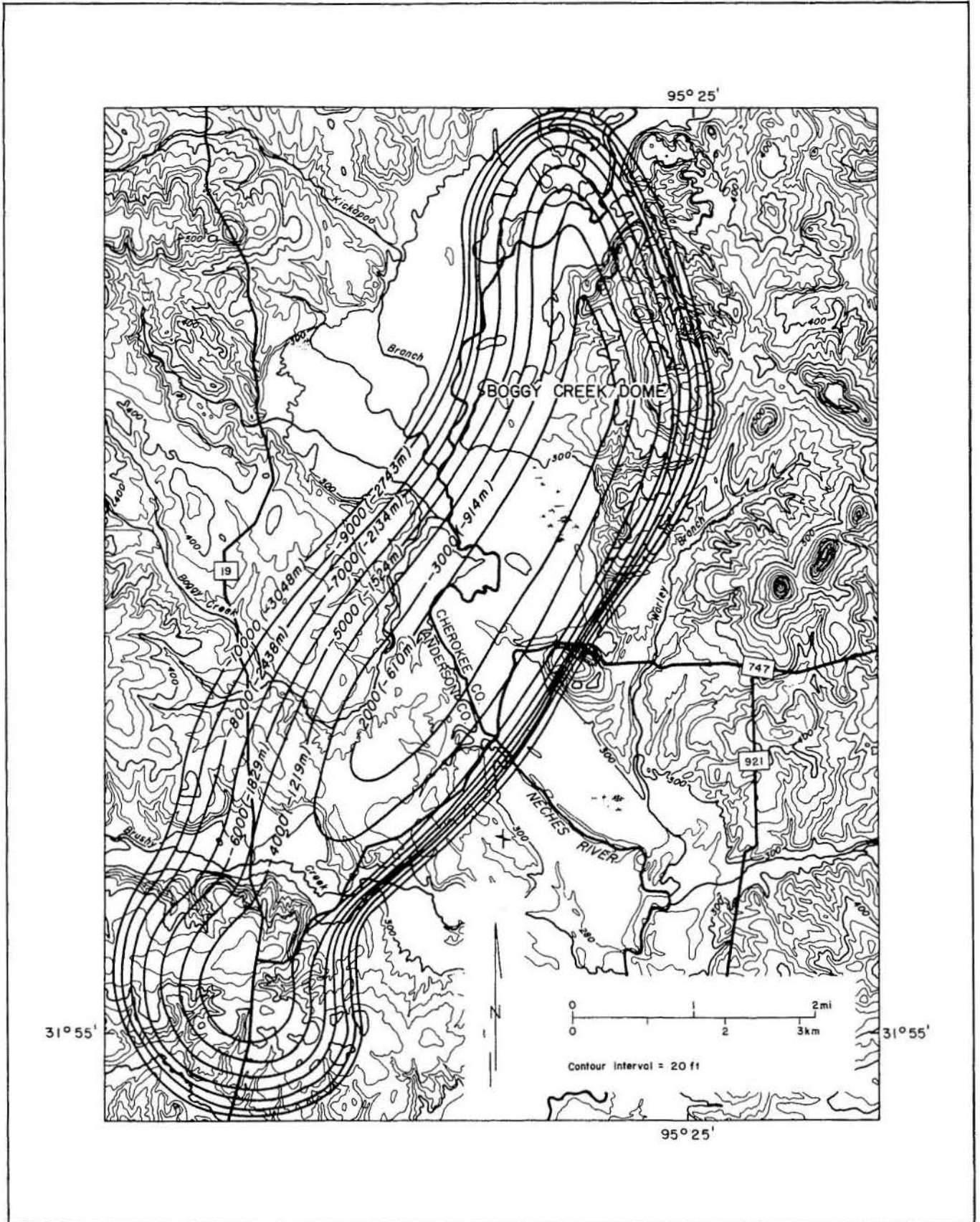

Figure 24. Map showing shape, location, topography, and drainage system of Bogy Creek Dome (salt structure contours from Giles, 1981).

BOGGY CREEK DOME (continued)

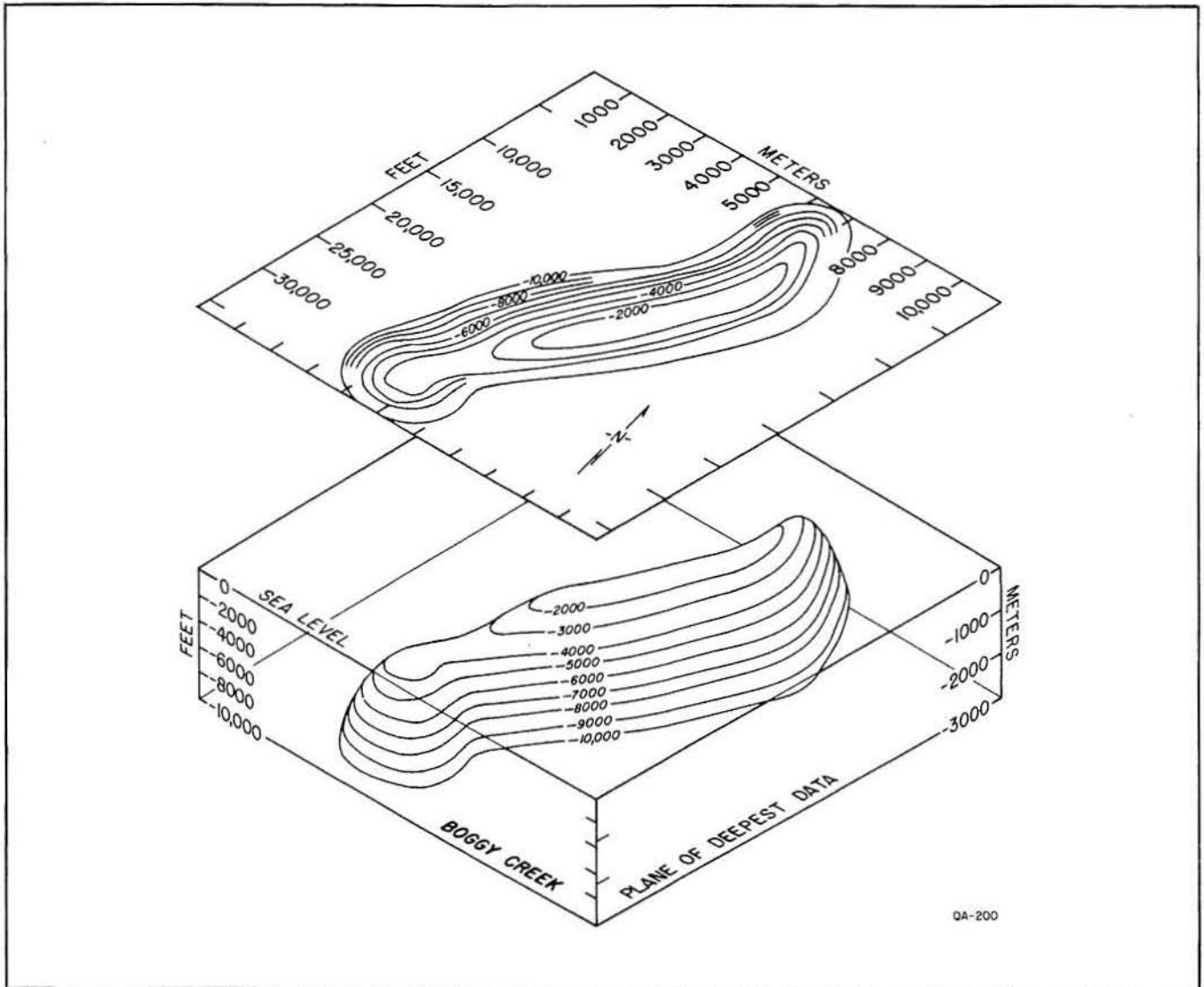

Figure 25. Isometric block diagram of Boggy Creek salt stock.

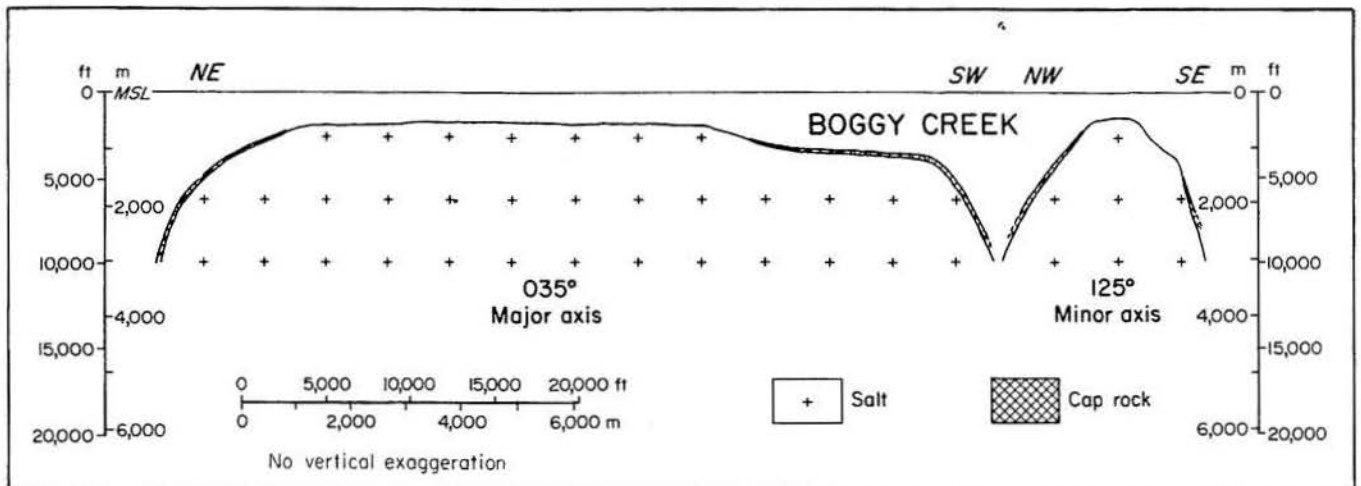
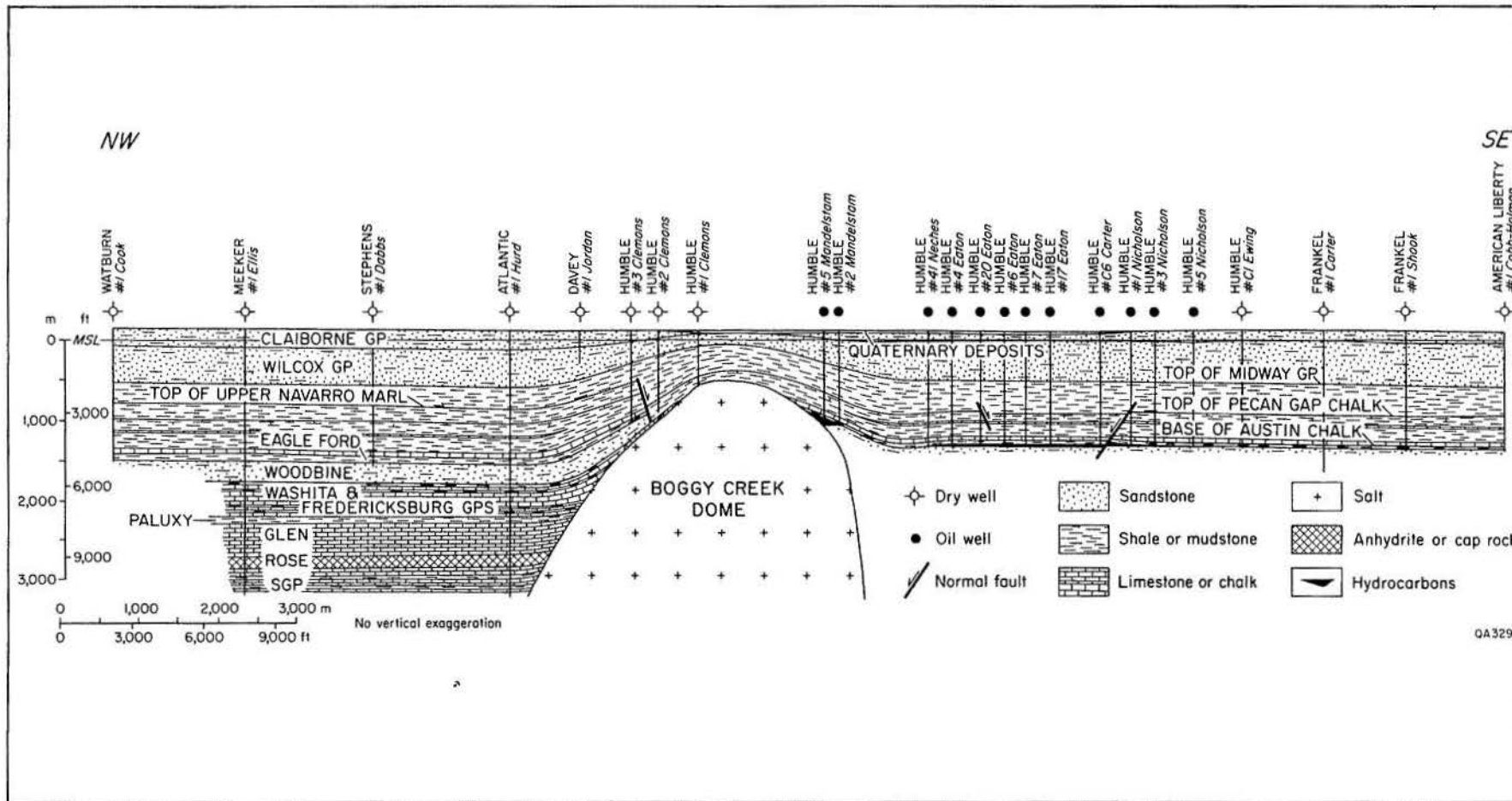

Figure 26. Orthogonal cross sections through major and minor axes of Boggy Creek salt stock.



BOGGY CREEK DOME (continued)

Figure 27. Structural cross section through Boggy Creek Dome (Giles and Wood, 1981).

QA329

DOME NAME: BROOKS

LOCATION:

SW Smith Co.
32° 09' 42" N; 95° 26' 38" W

RESIDUAL GRAVITY EXPRESSION:

-134 G units

DEPTH:

Depth to Cap Rock:

195 ft (59 m)

Depth to Salt Stock:

220 ft (67 m)

Depth to Top of Louann Salt (approximate):

21,000 ft (6,400 m)

ORIENTATION AND MAXIMUM LATERAL DIMENSIONS OF SALT STOCK:

Major Axis:

Length:

3.5 mi (5.6 km)

Orientation:

042°

Minor Axis:

Length:

3.3 mi (5.3 km)

Area:

8.8 mi² (22.5 km²)

Area of Planar Crest:

2.7 mi² (6.9 km²)

Percentage Planar Crest:

31%

SHAPE OF SALT STOCK:

General:

Piercement stock

Plan:

Circular (axial ratio = 1.06)

Cross Section:

Axis:

Vertical

Approximate Overall Symmetry:

Axial

Crest:

Complex

Sides:

Upward diverging from -7,000 ft to -5,500 ft (-2,134 m to -1,676 m); upward converging above -5,500 ft (-1,676 m); deepest data -7,000 ft (-2,134 m)

Overhang:

Well developed, circumdomal, symmetrical, elevation -5,500 ft (-1,676 m); maximum lateral overhang 600 ft (183 m) on N and S flanks; percentage overhang 18%

CAP ROCK:

Maximum Stratigraphic Thickness:

268 ft (82 m)

Minimum Stratigraphic Thickness:

20 ft (6 m)

Composition:

Calcite, anhydrite, gypsum

GEOMETRY OF ADJOINING STRATA:

Lateral Extent of Rim Syncline:

42,000 ft (12,800 m)

Lateral Extent of Drag Zone:

18,000 ft (5,500 m)

Vertical Variation in Maximum Dip of Strata:

$\Delta = -10^\circ$ at -10,000 ft (-3,048 m)
(Glen Rose)

$\Delta = 0^\circ$ at -6,000 ft (-1,829 m) (U. Washita)

$\Delta = +50^\circ$ at -3,000 ft (-900 m) (Austin)

$\Delta = +10^\circ$ at 0 ft (0 m) (Claiborne)

Angle Between Salt and Surrounding Strata:

$\delta = 130^\circ$ at -7,400 ft (-2,256 m) (Paluxy)

$\delta = 90^\circ$ at -4,300 ft (-1,311 m) (Woodbine)

$\delta = < 5^\circ$ above -3,000 ft (-914 m) (Austin)

Contact fault below Eagle Ford

Oldest Planar Overburden:

None

FAULTING OF ADJACENT STRATA:

Faults at Flanks:

No faults in section

Crestal Faults:

None

BROOKS DOME (continued)

Youngest Faulted Strata:

Unknown

Oldest Strata at Surface:

Austin Group: stratigraphic evidence of doming at surface

GROWTH HISTORY:

PRIMARY PERIPHERAL SINK:

Age of Initiation:

Pre-110 Ma

Age of Cessation:

Pre-110 Ma

Duration of Growth:

Unknown

Distance of Axial Trace from Center of Dome:

7 mi (11 km)

SECONDARY PERIPHERAL SINK:

Age of Initiation:

Pre-110 Ma

Age of Cessation:

90 Ma

TERTIARY PERIPHERAL SINK:

Age of Initiation:

90 Ma

Age of Cessation:

Post-50 Ma

AGE OF MIGRATION OF SINK TO SALT-STOCK CONTACT:

110 Ma

DOME-RELATED UNCONFORMITIES:

None recognized

Evidence for Extrusion and Erosion of Salt:

None recognized

YOUNGEST DEFORMATION:

Unknown

EVIDENCE OF SUBSIDENCE:

Equivocal

Configuration of Overburden Strata:

Claiborne and Wilcox strata absent over dome

Drainage System:

Type 3, supradomal depression, subcentripetal drainage

Sinkholes:

Man-made lake over dome crest

Surface Salines:

Present

RESOURCES AND USES:

HYDROCARBONS:

Number of Producing Wells:

Current: 0

Total: 1

Production:

Current: 0

Total: 1,199 bbls

Stratigraphic Reservoir:

Paluxy Formation

Traps:

Beneath overhang

ROCK SALT:

Solution mined

SULFUR:

None

GAS STORAGE:

None

BROOKS DOME (continued)

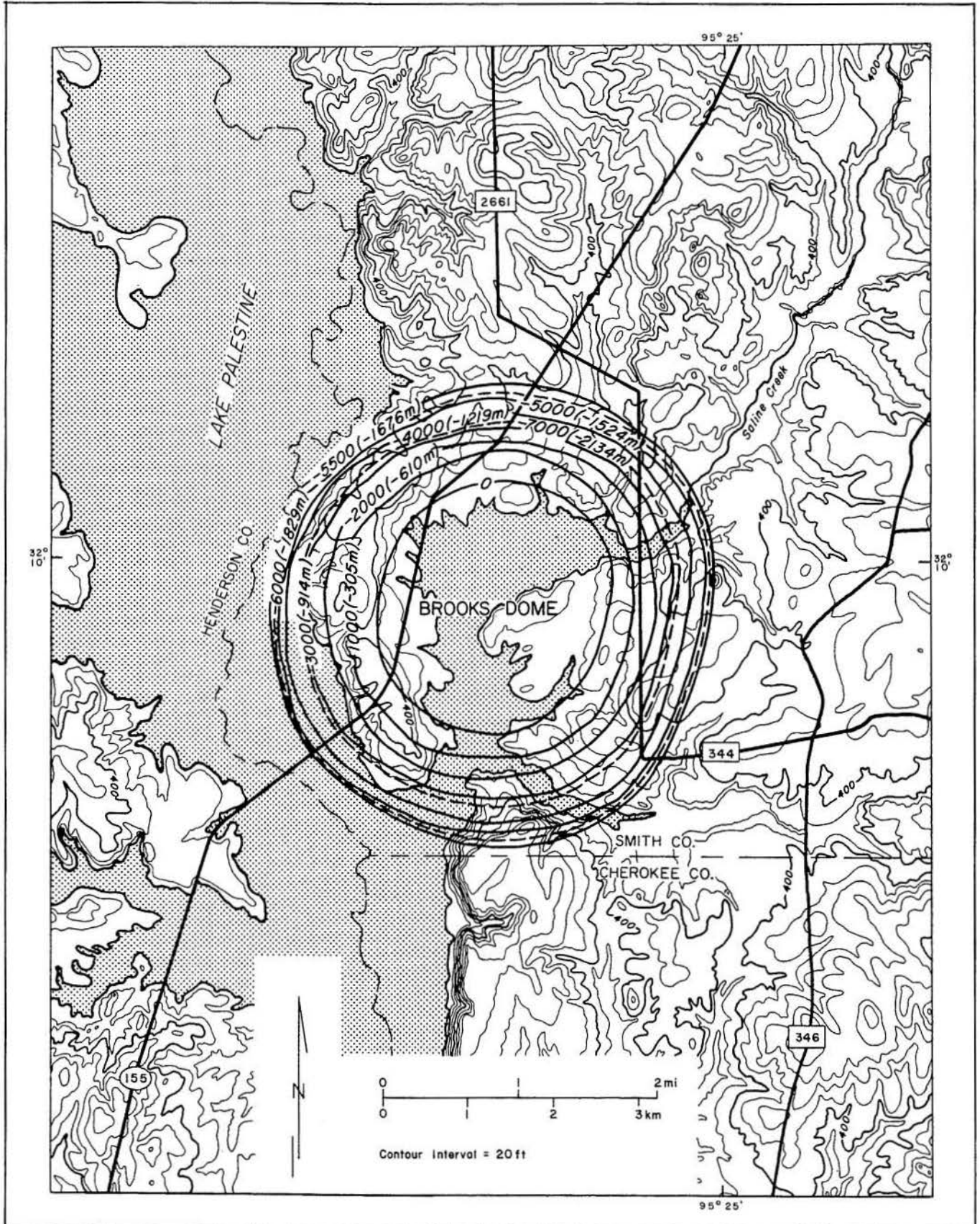

Figure 28. Map showing shape, location, topography, and drainage system of Brooks Dome (salt structure contours from Giles, 1980).

BROOKS DOME (continued)

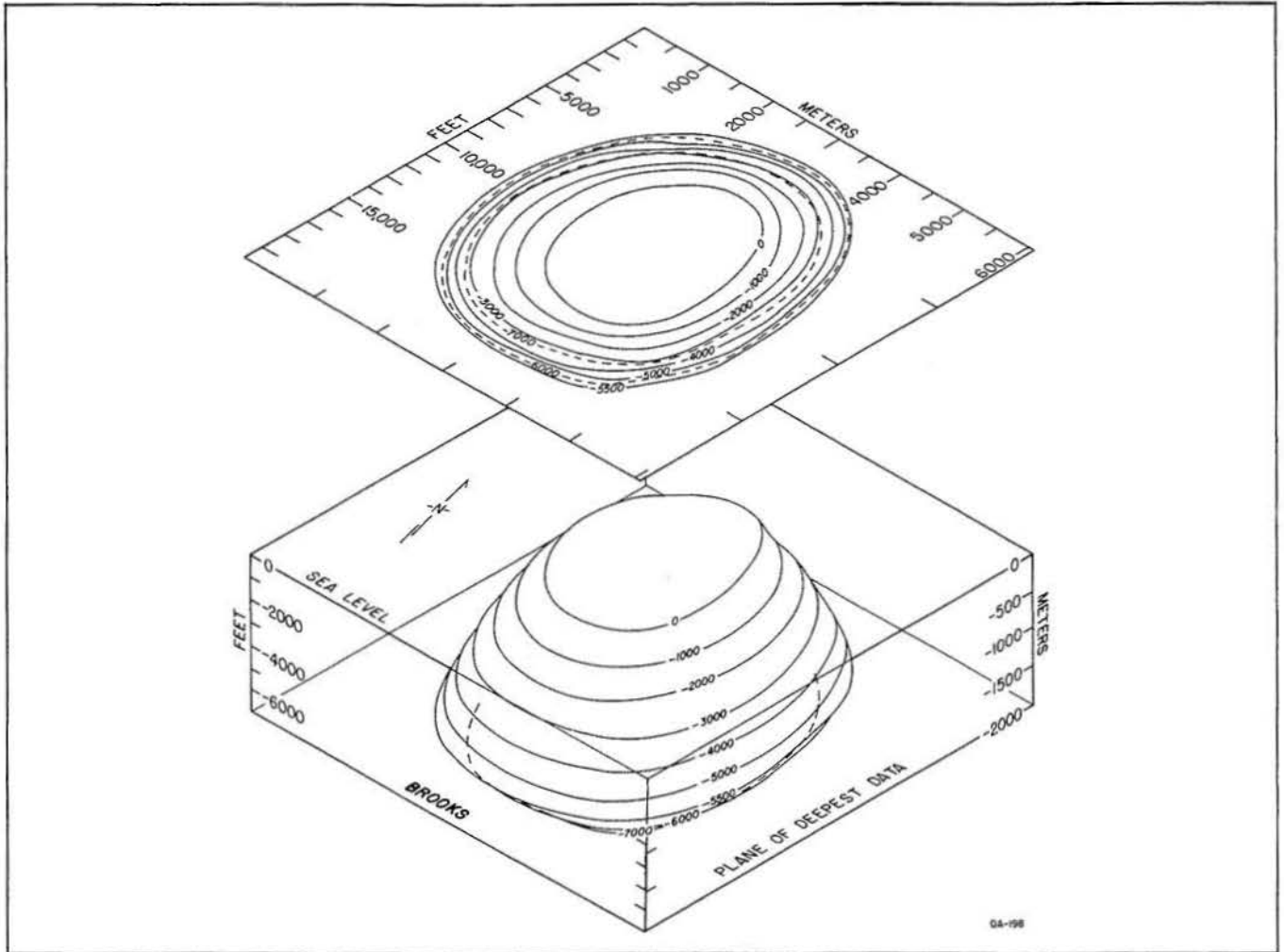

Figure 29. Isometric block diagram of Brooks salt stock.

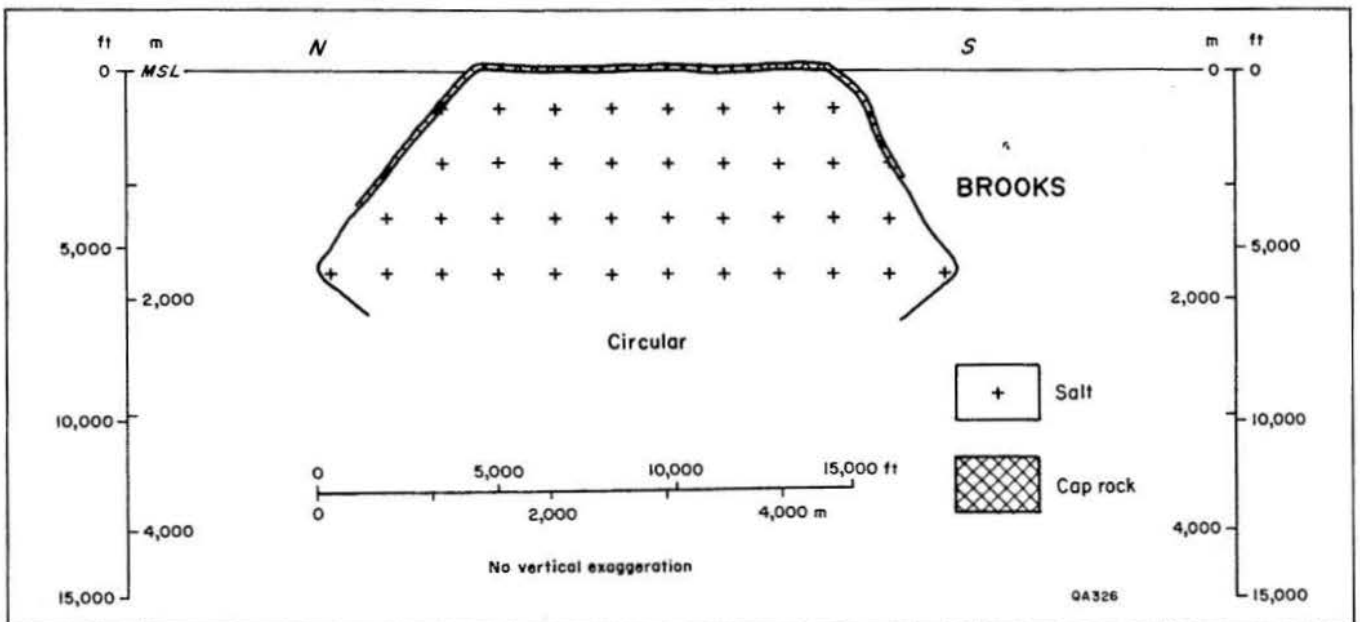
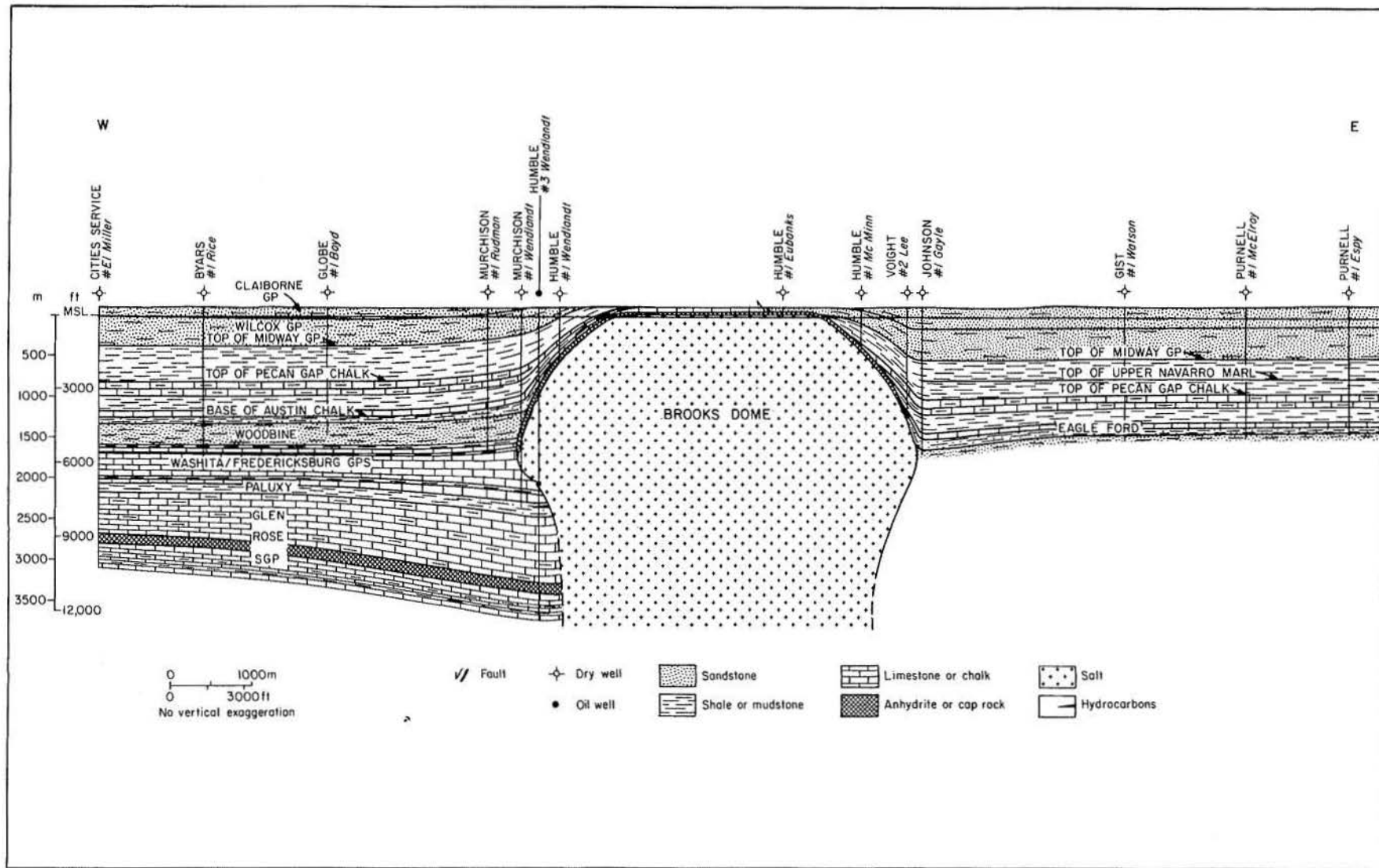

Figure 30. Cross section through Brooks salt stock, which is axially symmetric.



BROOKS DOME (continued)

Figure 31. Structural cross section through Brooks Dome (Wood and Giles, 1982).

DOMES NAME: BRUSHY CREEK

LOCATION:

NE Anderson Co.
31° 55' 27" N; 95° 35' 50" W

RESIDUAL GRAVITY EXPRESSION:

-36 G units

DEPTH:

Depth to Cap Rock:

3,522 ft (1,074 m)

Depth to Salt Stock:

3,570 ft (1,088 m)

Depth to Top of Louann Salt (approximate):

22,000 ft (6,700 m)

ORIENTATION AND MAXIMUM LATERAL DIMENSIONS OF SALT STOCK:

Major Axis:

Length:

> 1.6 mi (> 2.6 km)

Orientation:

None, circular

Minor Axis:

Length:

> 1.56 mi (> 2.5 km)

Area:

> 1.9 mi² (> 4.9 km²)

Area of Planar Crest:

0.5 mi² (1.3 km²)

Percentage Planar Crest:

26%

SHAPE OF SALT STOCK:

General:

Probably piercement stock (configuration below -4,000 ft [-1,219 m] unknown)

Plan:

Circular (axial ratio = 1.03)

Cross Section:

Axis:

Insufficient deep data

Approximate Overall Symmetry:

Unknown

Crest:

Complex

Sides:

Upward converging above -4,000 ft (-1,219 m); deepest data -4,000 ft (-1,219 m)

Overhang:

None recognized above -4,000 ft (-1,219 m)

CAP ROCK:

Maximum Stratigraphic Thickness:

187 ft (57 m) on upper flanks of dome; absent on dome crest

Minimum Stratigraphic Thickness:

81 ft (25 m)

Composition:

Calcite, anhydrite, minor celestite

GEOMETRY OF ADJOINING STRATA:

Lateral Extent of Rim Syncline:

25,500 ft (7,800 m)

Lateral Extent of Drag Zone:

15,000 ft (4,570 m)

Vertical Variation in Maximum Dip of Strata:

$\Delta = -3^\circ$ at -11,000 ft (-3,353 m) (Hosston)

$\Delta = 0^\circ$ from -7,000 ft (-2,134 m) (Paluxy) to -4,500 ft (-1,372 m) (Austin)

Δ decreases from $+15^\circ$ at -3,000 ft (-914 m) (Austin) to $+5^\circ$ at 0 ft (0 m) (Claiborne)

Angle Between Salt and Surrounding Strata:

$\delta \approx 90^\circ$ at -11,500 ft (-3,505 m) (Travis Peak)

$\delta = 40^\circ$ at -4,000 ft (-1,219 m) (Woodbine)

$\delta = 0^\circ$ at -3,300 ft (-1,006 m) (Woodbine)

Contact fault below Woodbine Group

Oldest Planar Overburden:

None

FAULTING OF ADJACENT STRATA:

Faults at Flanks:

SW side: multiple offset, normal, down-to-dome, antithetic (middle Glen Rose); multiple offset, normal, up-to-dome, antithetic (Paluxy); normal, down-to-dome (Austin)

BRUSHY CREEK DOME (continued)

Crestal Faults:

Central graben, antithetic pair, in domal crest

Youngest Faulted Strata:

Claiborne Group

Oldest Strata at Surface:

Claiborne Group: no stratigraphic evidence of doming at surface

GROWTH HISTORY:

PRIMARY PERIPHERAL SINK:

Age of Initiation:

Pre-110 Ma

Age of Cessation:

Pre-110 Ma

Duration of Growth:

Unknown

Distance of Axial Trace from Center of Dome:

5 to 8 mi (8 to 13 km)

SECONDARY PERIPHERAL SINK:

Age of Initiation:

Pre-110 Ma

Age of Cessation:

100 Ma

TERTIARY PERIPHERAL SINK:

Age of Initiation:

100 Ma

Age of Cessation:

Post-50 Ma

AGE OF MIGRATION OF SINK TO SALT-STOCK CONTACT:

Sink has not migrated to salt stock

DOME-RELATED UNCONFORMITIES:

None recognized

Evidence of Extrusion and Erosion of Salt:

None recognized

YOUNGEST DEFORMATION:

Fault in Claiborne Group

EVIDENCE OF SUBSIDENCE:

Present

Configuration of Overburden Strata:

Central graben over dome crest

Drainage System:

Type 4, transverse drainage

Sinkholes:

None

Surface Salines:

None

RESOURCES AND USES:

HYDROCARBONS:

2 fields; Purt (Woodbine) and West Purt (Rodessa)

Number of Producing Wells:

Current:

2 (West Purt; Purt)

Total:

6 (1 Rodessa; 5 Woodbine)

Production:

Current:

3,866 bbl (Purt)

2,087 bbl (West Purt)

Total:

137,976 bbl (Purt)

35,992 bbl (West Purt)

Stratigraphic Reservoir:

Woodbine Group (Purt); Rodessa Member (West Purt)

Traps:

Supradomal faults and anticline (Purt); flank fault (West Purt)

ROCK SALT:

Not mined

SULFUR:

None

GAS STORAGE:

None

BRUSHY CREEK DOME (continued)

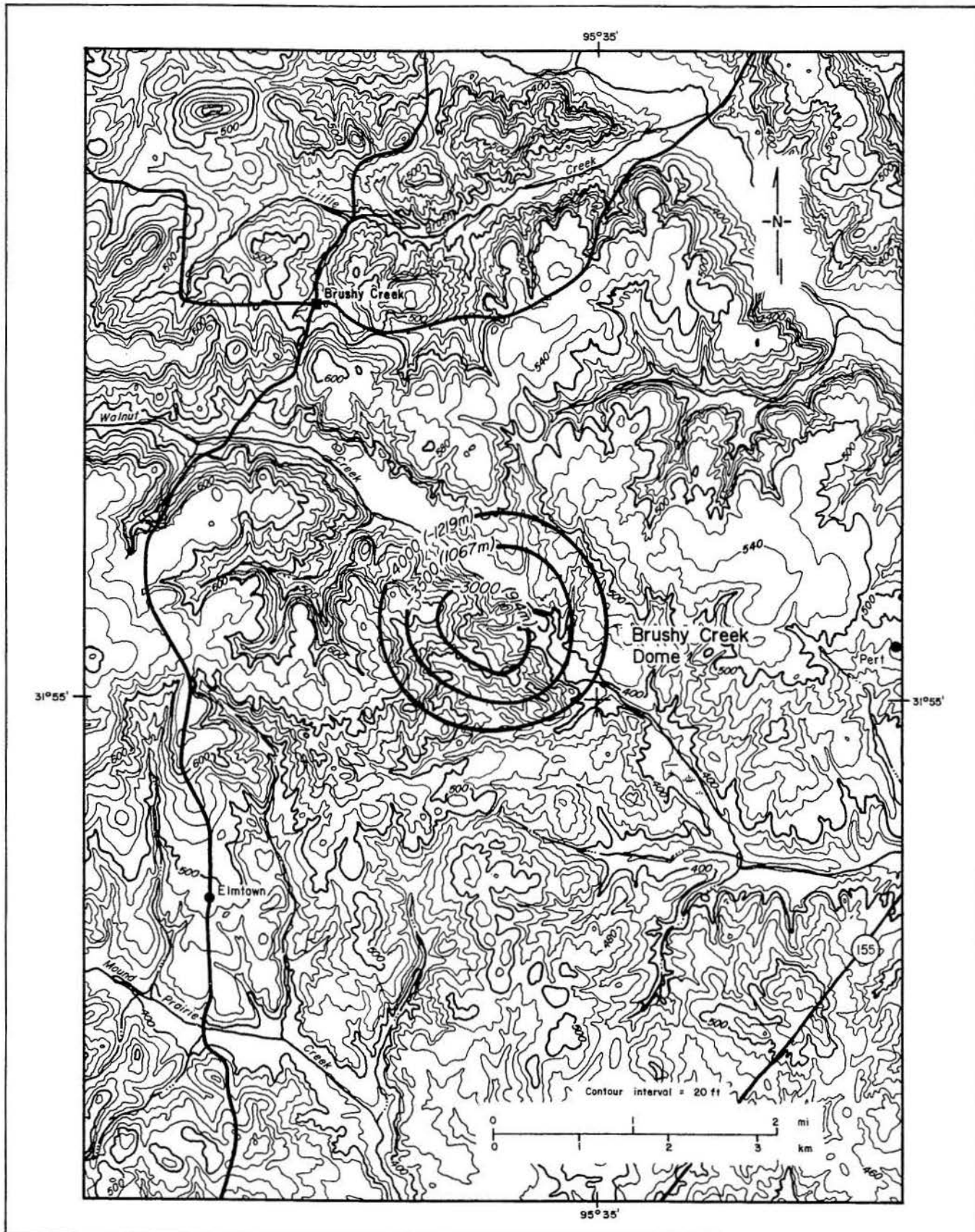

Figure 32. Map showing shape, location, topography, and drainage system of Brushy Creek Dome (salt structure contours from Giles, 1980).

BRUSHY CREEK DOME (continued)

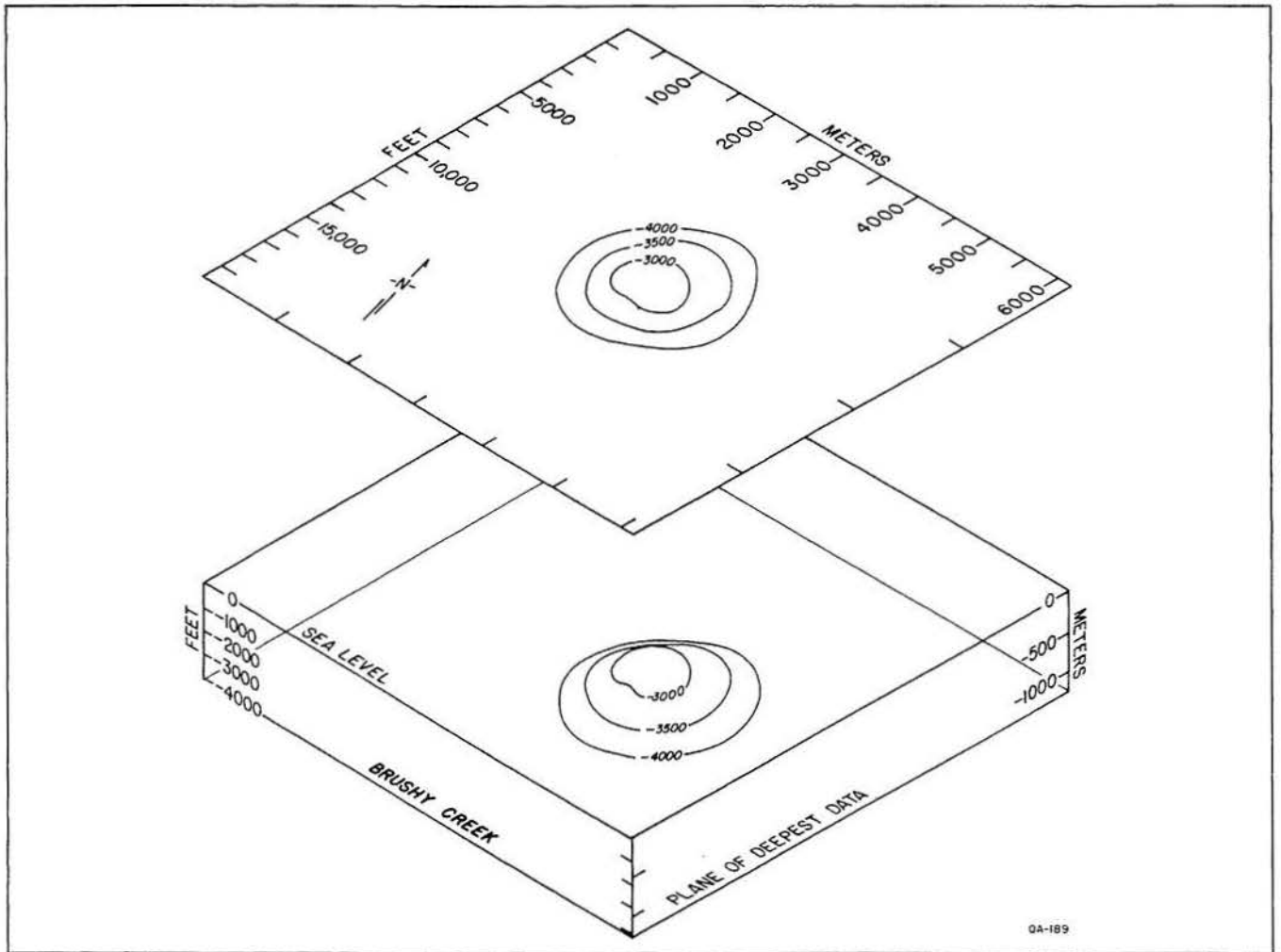

Figure 33. Isometric block diagram of Brushy Creek salt stock.

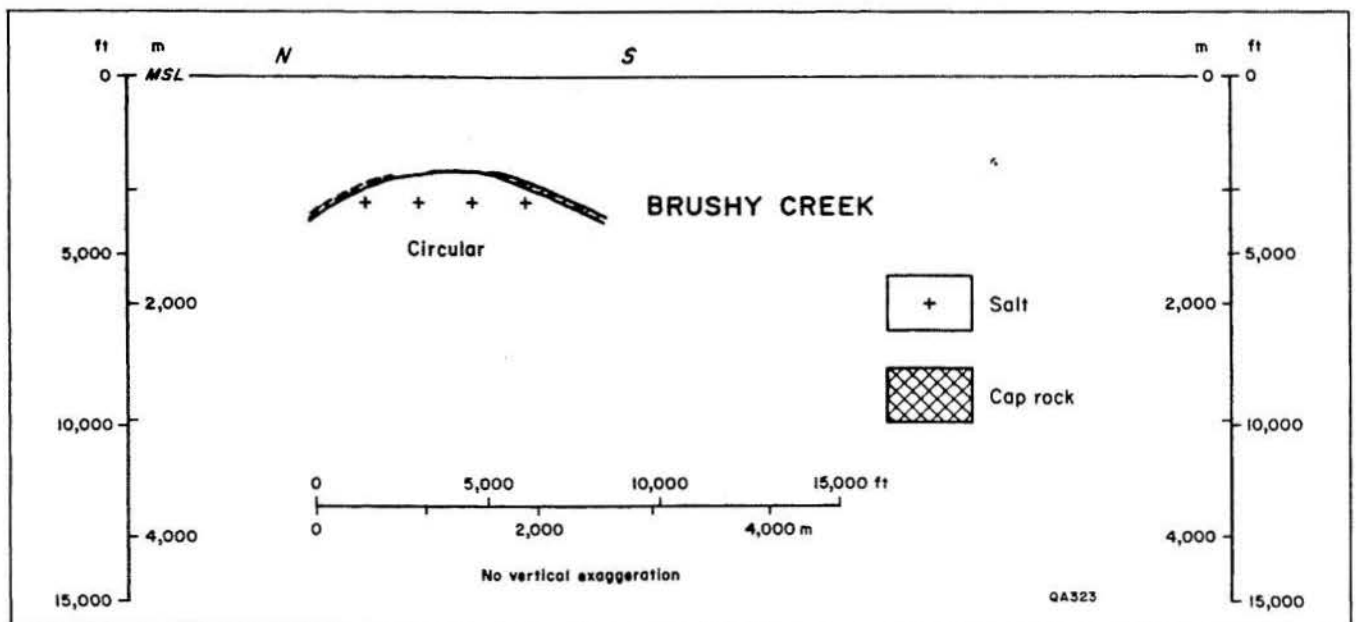

Figure 34. Cross section through Brushy Creek salt stock, which is axially symmetric.

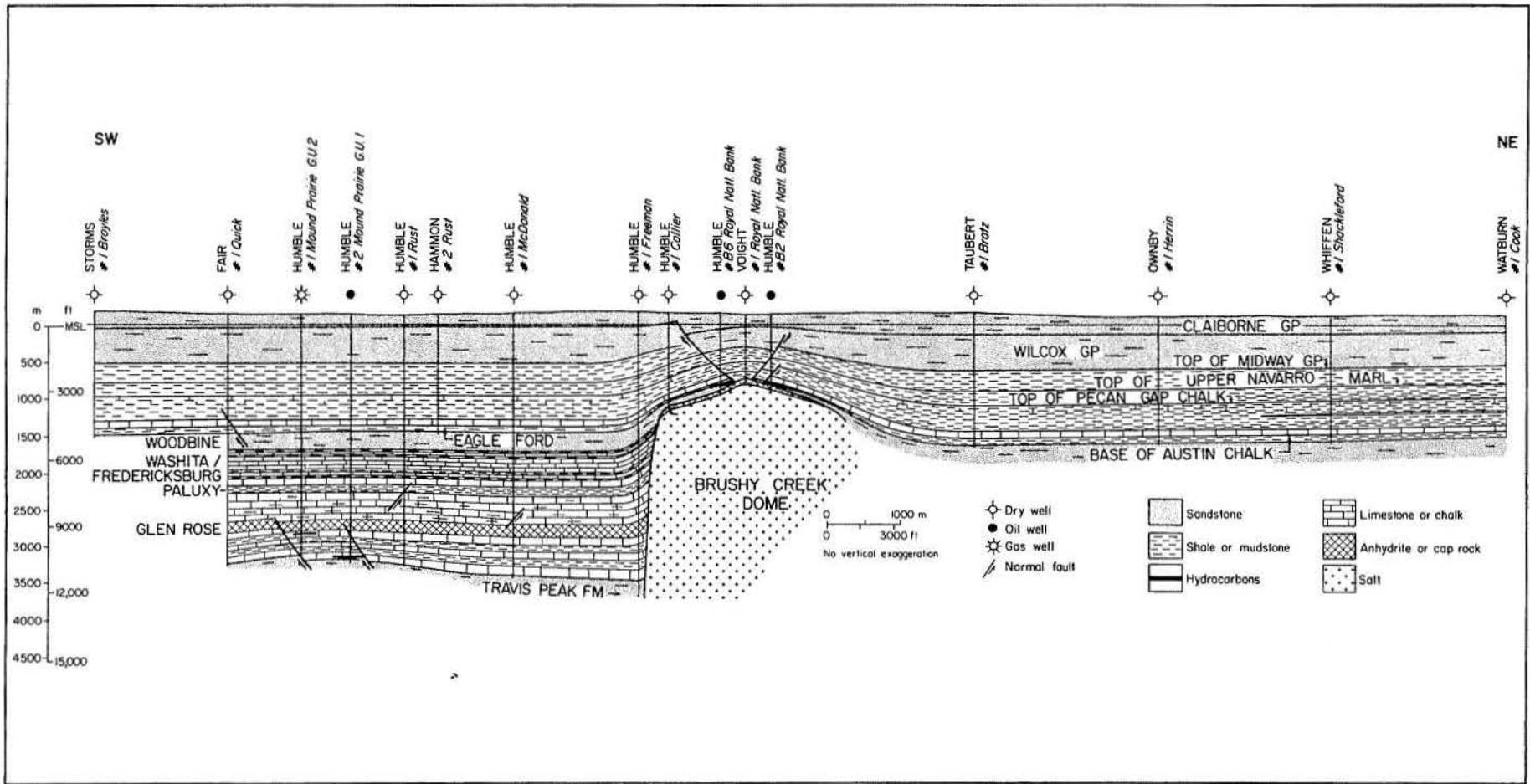

Figure 35. Structural cross section through Brushy Creek Dome (Wood and Giles, 1982).

DOME NAME: BULLARD

LOCATION:

South-central Smith Co.
32° 09' 20" N; 95° 17' 38" W

RESIDUAL GRAVITY EXPRESSION:

-48 G units

DEPTH:

Depth to Cap Rock:

375 ft (114 m)

Depth to Salt Stock:

527 ft (161 m)

Depth to Top of Louann Salt (approximate):

22,000 ft (6,700 m)

ORIENTATION AND MAXIMUM LATERAL DIMENSIONS OF SALT STOCK:

Major Axis:

Length:

1 mi (1.6 km)
at -4,000 ft
(-1,219 m)

Orientation:

095°

Minor Axis:

Length:

0.5 mi (0.8 km)

Area:

0.5 mi² (1.3 km²)

Area of Planar Crest:

0.1 mi² (0.3 km²)

Percentage Planar Crest:

20%

SHAPE OF SALT STOCK:

General:

Piercement stock

Plan:

Irregular; circular (axial ratio = 1.07) at
-10,000 ft to -6,000 ft (-3,048 m to -1,829 m);
elliptical (axial ratio = 1.8) above -6,000 ft
(-1,829 m)

Cross Section:

Axis:

Axial plunge 75°; tilt direction 213°;
tilt distance 2,112 ft (644 m)

Approximate Overall Symmetry:

Triclinic

Crest:

Complex

Sides:

Irregularly upward converging above
-10,000 ft (-3,048 m); deepest data
-10,000 ft (-3,048 m)

Overhang:

Minor overhang on W flank, elevation
-4,000 ft (-1,219 m); maximum lateral
overhang 500 ft (152 m)

CAP ROCK:

Maximum Stratigraphic Thickness:

152 ft (46 m)

Minimum Stratigraphic Thickness:

145 ft (44 m)

Composition:

Anhydrite, calcite

GEOMETRY OF ADJOINING STRATA:

Lateral Extent of Rim Syncline:

24,000 ft (7,315 m)

Lateral Extent of Drag Zone:

9,000 ft (2,743 m)

Vertical Variation in Maximum Dip of Strata:

$\Delta = 2^\circ$ at -4,900 ft (-1,494 m) (Woodbine)

$\Delta = 0^\circ$ at -4,500 ft (-1,372 m)
(Austin Chalk)

$\Delta = +35^\circ$ at -3,000 ft (-914 m) (Pecan Gap)

$\Delta = +5^\circ$ at 0 ft (0 m) (Claiborne)

Angle Between Salt and Surrounding Strata:

$\delta > 30^\circ$ from depth to 0 ft (0 m) (Claiborne)

Contact fault below Claiborne Group

Oldest Planar Overburden:

None

BULLARD DOME (continued)

FAULTING OF ADJACENT STRATA:

Faults at Flanks:

No faults in section

Crestal Faults:

No faults in section

Youngest Faulted Strata:

Unknown

Oldest Strata at Surface:

Queen City Formation: no stratigraphic evidence of doming at surface

GROWTH HISTORY:

PRIMARY PERIPHERAL SINK:

Age of Initiation:

Pre-110 Ma

Age of Cessation:

Pre-110 Ma

Duration of Growth:

Unknown

Distance of Axial Trace from Center of Dome:

5 to 6 mi (8 to 10 km)

SECONDARY PERIPHERAL SINK:

Age of Initiation:

Pre-110 Ma

Age of Cessation:

Pre-110 Ma

TERTIARY PERIPHERAL SINK:

Age of Initiation:

Pre-110 Ma

Age of Cessation:

Post-50 Ma

AGE OF MIGRATION OF SINK TO SALT-STOCK CONTACT:

Unknown

DOME-RELATED UNCONFORMITIES:

None recognized

Evidence of Extrusion and Erosion of Salt:

None recognized

YOUNGEST DEFORMATION:

Wilcox strata arch over dome crest

EVIDENCE OF SUBSIDENCE:

None

Configuration of Overburden Strata:

Claiborne strata flat-lying over crest of dome

Drainage System:

Type 3, subcentripetal drainage

Sinkholes:

None

Surface Salines:

None

RESOURCES AND USES:

HYDROCARBONS:

Number of Producing Wells:

Current: 0

Total: 0

Production:

Current: 0

Total: 0

Stratigraphic Reservoir:

None

Traps:

None

ROCK SALT:

Not mined

SULFUR:

None

GAS STORAGE:

None

BULLARD DOME (continued)

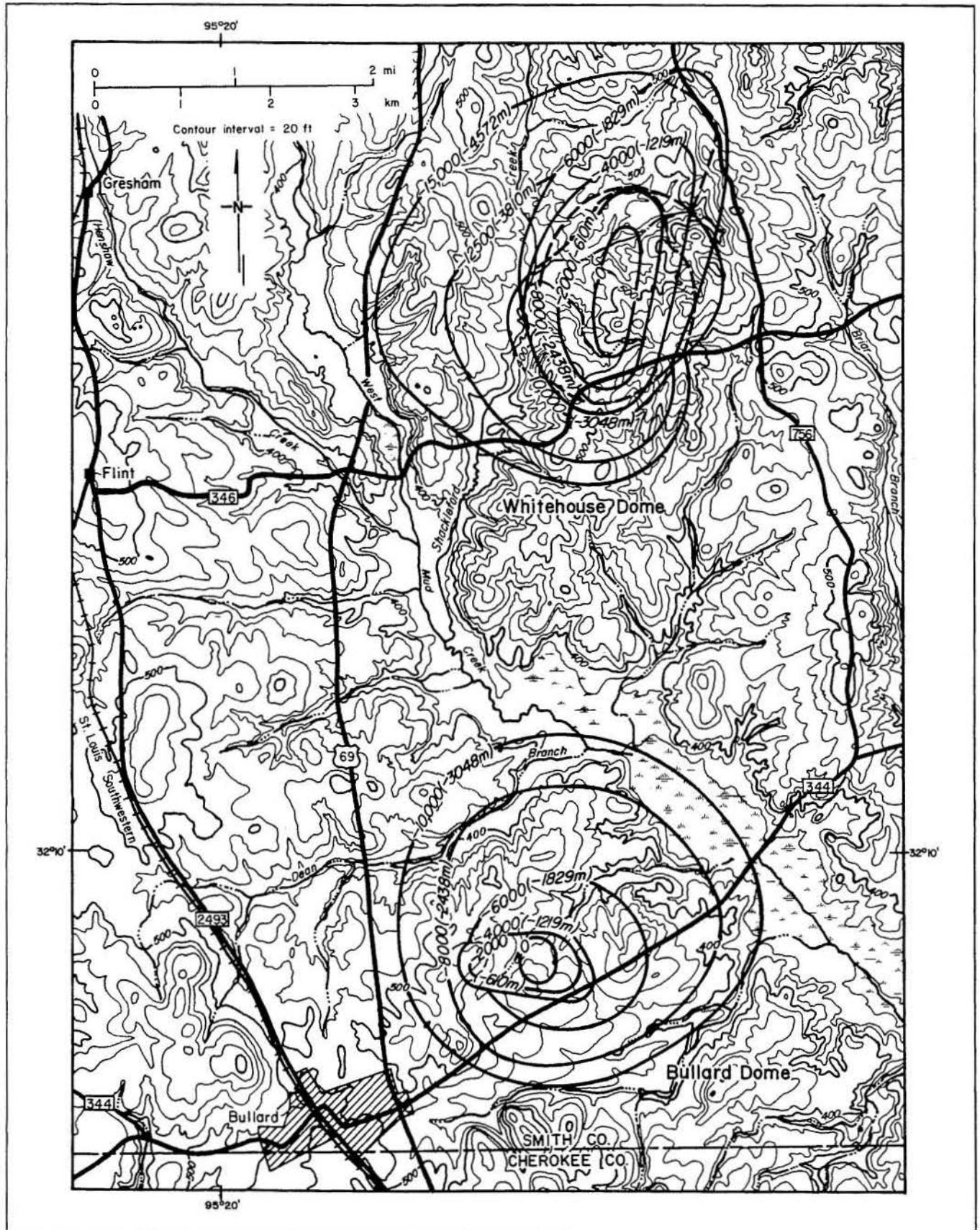

Figure 36. Map showing shapes, locations, topography, and drainage systems of Bullard and Whitehouse Domes (salt structure contours from Netherland, Sewell and Associates, 1976).

BULLARD DOME (continued)

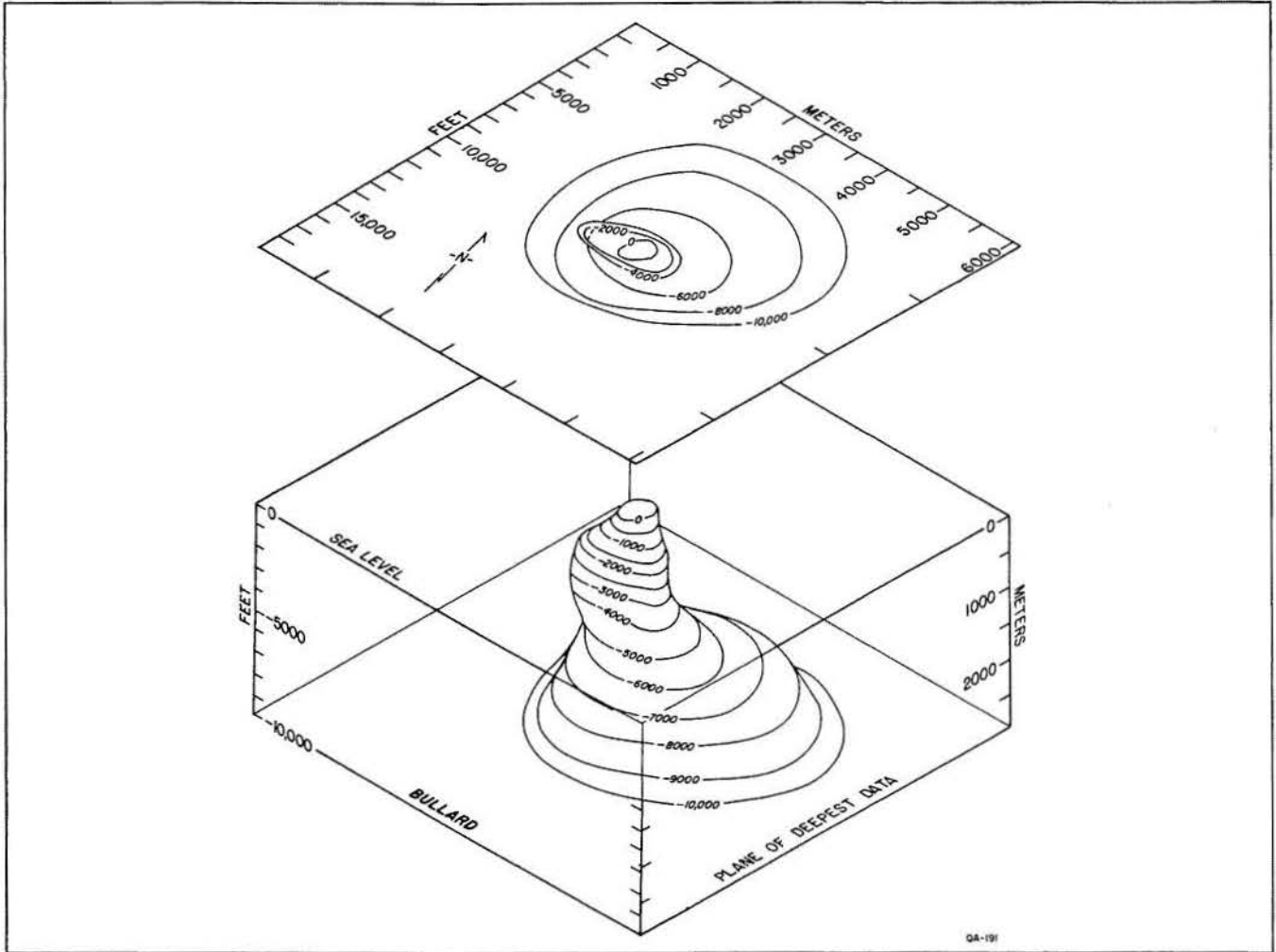

Figure 37. Isometric block diagram of Bullard salt stock.

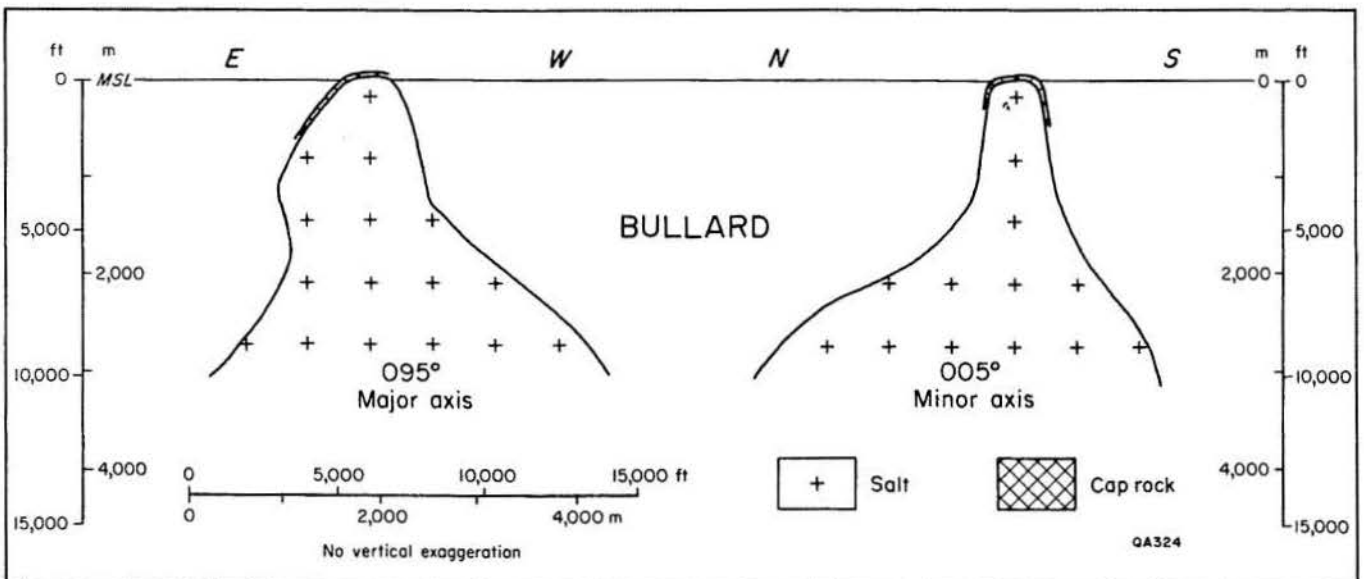

Figure 38. Orthogonal cross sections through major and minor axes of Bullard salt stock.

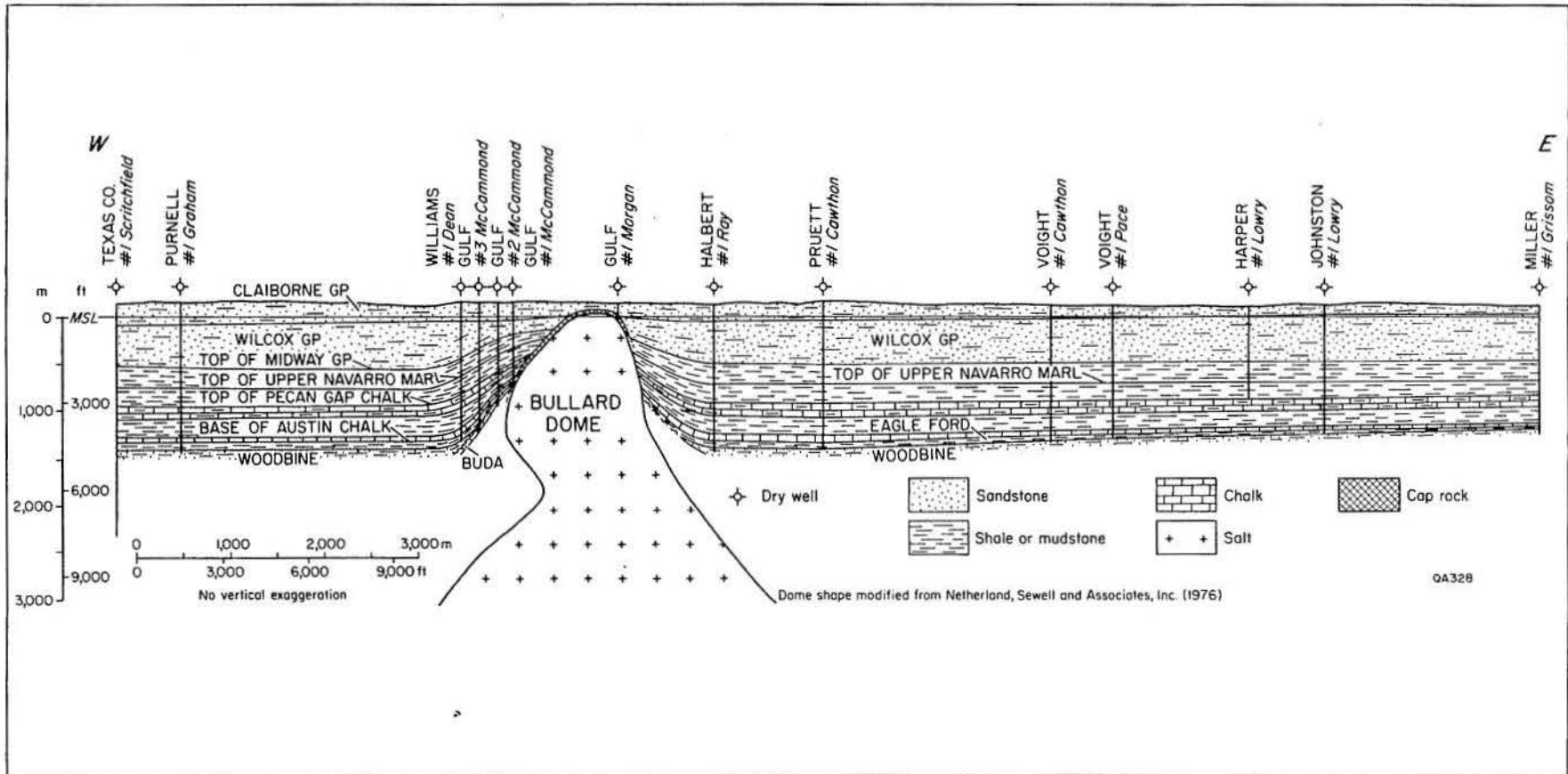

Figure 39. Structural cross section through Bullard Dome (Giles, 1980).

DOME NAME: BUTLER

LOCATION:

SE Freestone Co.
31° 40' 07" N; 95° 51' 52" W

RESIDUAL GRAVITY EXPRESSION:

-80 G units

DEPTH:

Depth to Cap Rock:

No cap rock

Depth to Salt Stock:

312 ft (95 m)

Depth to Top of Louann Salt (approximate):

21,000 ft (6,400 m)

ORIENTATION AND MAXIMUM LATERAL DIMENSIONS OF SALT STOCK:

Major Axis:

Length:

2.5 mi (4.0 km)

Orientation:

055°

Minor Axis:

Length:

2.2 mi (3.5 km)

Area:

4.4 mi² (11.3 km²)

Area of Planar Crest:

0.5 mi² (1.3 km²)

Percentage Planar Crest:

11%

SHAPE OF SALT STOCK:

General:

Piercement stock

Plan:

Slightly elliptical (axial ratio = 1.1)

Cross Section:

Axis:

Vertical

Approximate Overall Symmetry:

Orthorhombic

Crest:

Complex

Sides:

Upward diverging from -8,000 ft to -5,000 ft (-2,438 m to -1,524 m); upward converging above -5,000 ft (-1,524 m); deepest data -8,000 ft (-2,438 m)

Overhang:

Moderate, circum-domal, symmetrical, elevation -5,000 ft (-1,524 m); maximum lateral overhang 1,200 ft (366 m) on N flank; percentage overhang 24%

CAP ROCK:

Maximum Stratigraphic Thickness:

Cap rock absent

Minimum Stratigraphic Thickness:

Cap rock absent

Unusual calcite-cemented Carrizo Formation (false cap rock) overlies NW flank of dome

GEOMETRY OF ADJOINING STRATA:

Lateral Extent of Rim Syncline:

32,800 ft (9,998 m)

Lateral Extent of Drag Zone:

16,400 ft (4,999 m)

Vertical Variation in Maximum Dip of Strata:

$\Delta = -13^\circ$ at -9,000 ft (-2,743 m)
(middle Glen Rose)

$\Delta = 0^\circ$ at -5,600 ft (-1,707 m) (Woodbine)

$\Delta = +30^\circ$ at -1,600 ft (-488 m) (Woodbine)
to 0 ft (Navarro)

Angle Between Salt and Surrounding Strata:

$\delta = 115^\circ$ at -6,550 ft (-1,996 m) (Washita)

$\delta = 90^\circ$ at -5,600 ft (-1,707 m) (Washita)

$\delta < 15^\circ$ from 3,600 ft (-1,097 m) (Austin)
to 0 ft (Navarro)

Contact fault below Pecan Gap Chalk

Oldest Planar Overburden:

None

FAULTING OF ADJACENT STRATA:

Faults at Flanks:

None

BUTLER DOME (continued)

Crestal Faults:

One in SW, normal, homothetic, up-to-dome, simple offset, central half-horst of trapdoor type (lower Austin Group to surface)

Youngest Faulted Strata:

Claiborne Group

Oldest Strata at Surface:

Navarro Group: stratigraphic evidence of doming at surface

GROWTH HISTORY:

PRIMARY PERIPHERAL SINK:

Age of Initiation:

150 Ma

Age of Cessation:

130 Ma

Duration of Growth:

20 Ma

Distance of Axial Trace from Center of Dome:

5 to 7 mi (8 to 11 km)

SECONDARY PERIPHERAL SINK:

Age of Initiation:

130 Ma

Age of Cessation:

120 Ma

TERTIARY PERIPHERAL SINK:

Age of Initiation:

120 Ma

Age of Cessation:

Post-50 Ma

AGE OF MIGRATION OF SINK TO SALT-STOCK CONTACT:

110 Ma

DOME-RELATED UNCONFORMITIES:

Common in Claiborne strata above salt stock

Evidence of Extrusion and Erosion of Salt:

None recognized

YOUNGEST DEFORMATION:

Fault in Claiborne Group

EVIDENCE OF SUBSIDENCE:

Present

Configuration of Overburden Strata:

Anticlinal

Drainage System:

Type 2, supradomal depression, central centripetal drainage. Man-made lake over NE flank.

Sinkholes:

Common

Surface Salines:

Present

RESOURCES AND USES:

HYDROCARBONS:

Number of Producing Wells:

Current: 0

Total: 1

Production:

Current: 0

Total: 763 bbl

Stratigraphic Reservoir:

Woodbine Group

Traps:

Truncation by side of salt stock

ROCK SALT:

Not mined; "false cap rock" (calcite-cemented Carrizo sandstone) quarried above dome

SULFUR:

None

GAS STORAGE:

3 wells for LPG storage

BUTLER DOME (continued)

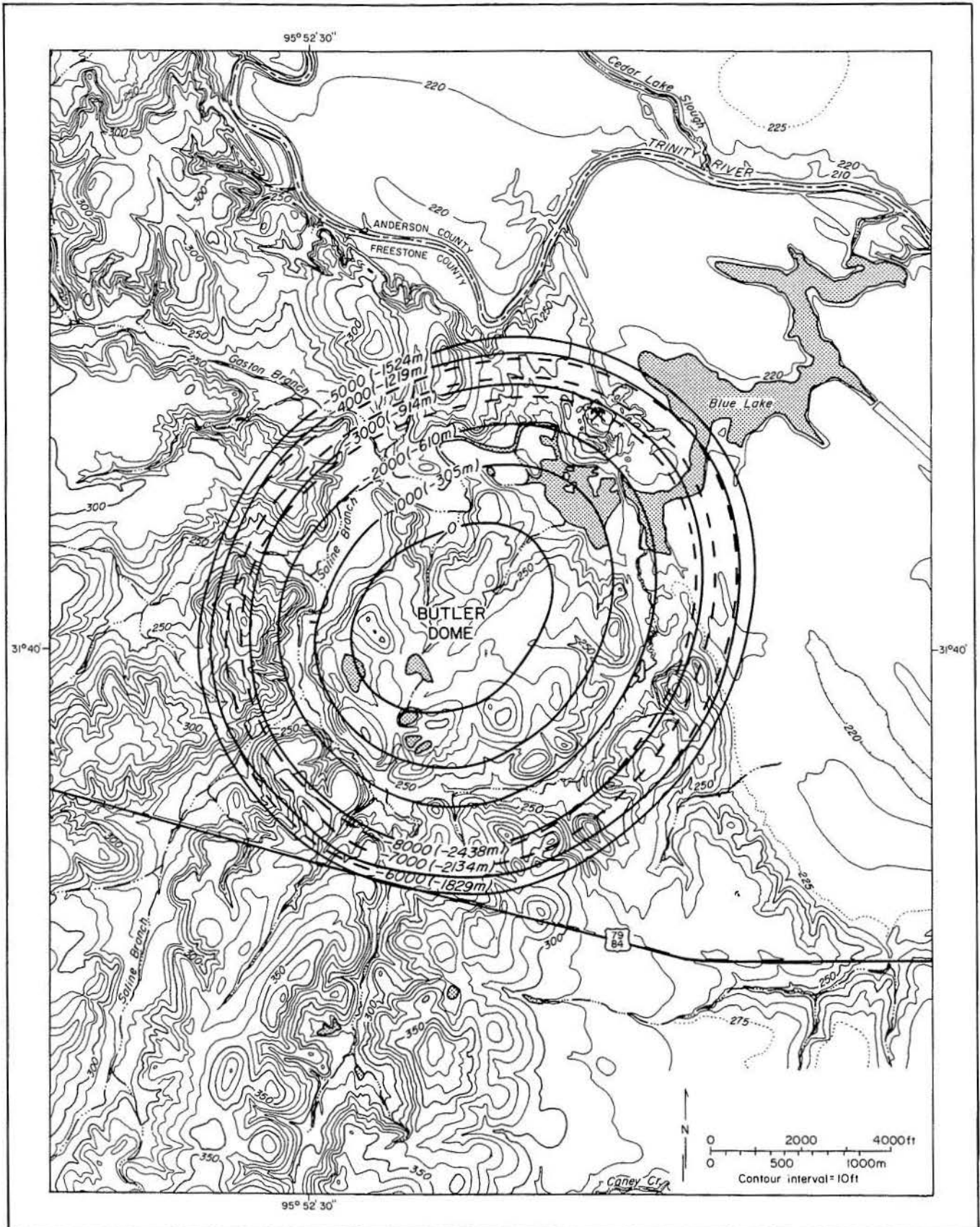

Figure 40. Map showing shape, location, topography, and drainage system of Butler Dome (salt structure contours from Giles, 1980).

BUTLER DOME (continued)

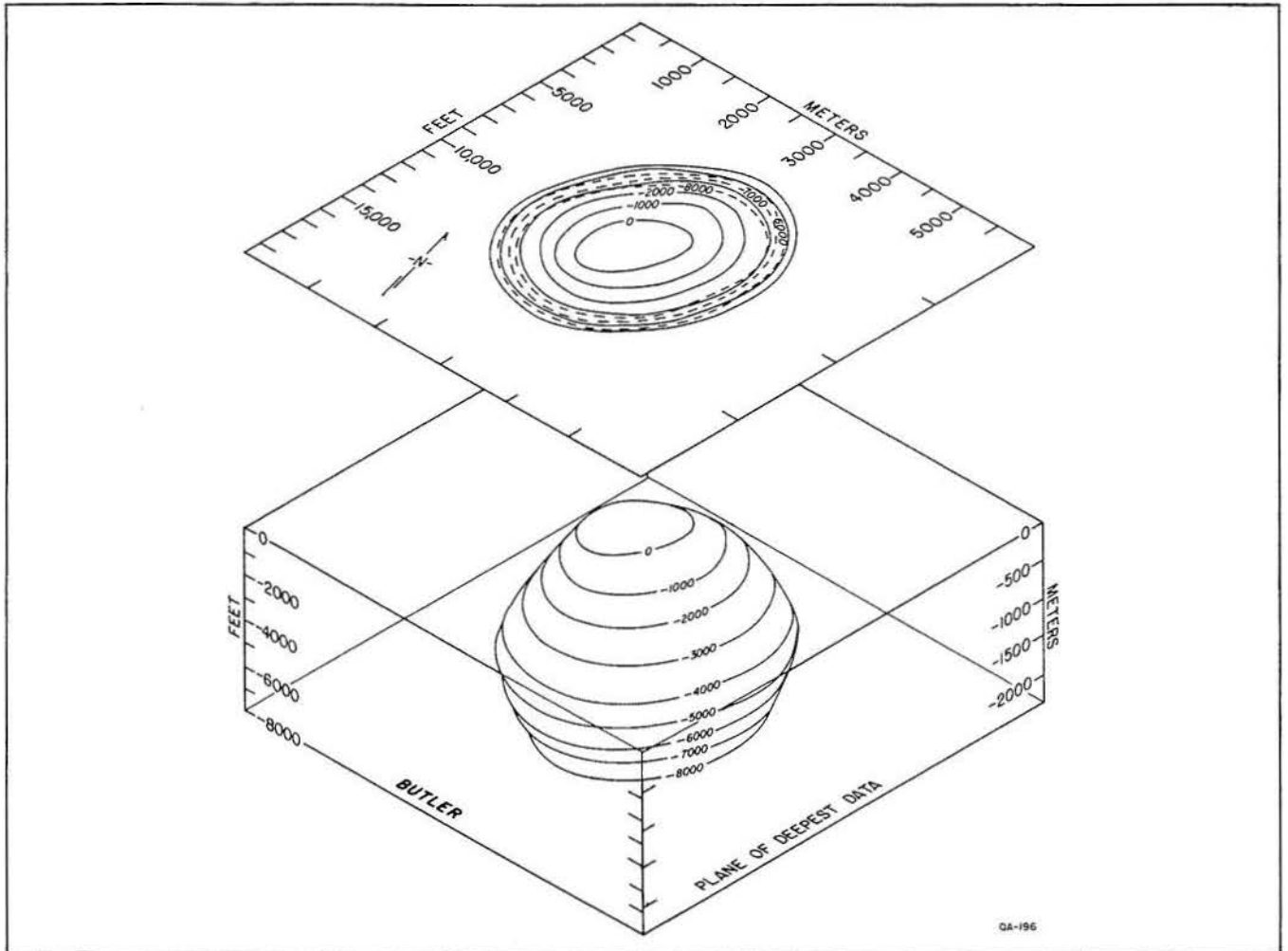

Figure 41. Isometric block diagram of Butler salt stock.

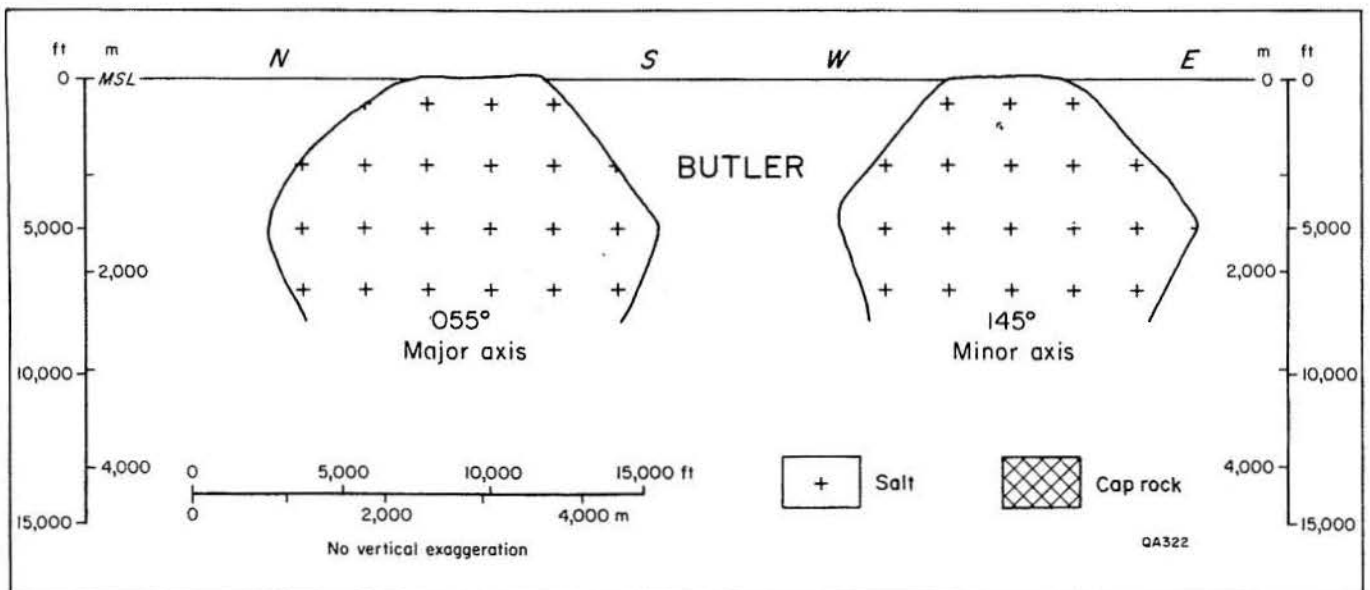

Figure 42. Orthogonal cross sections through major and minor axes of Butler salt stock.

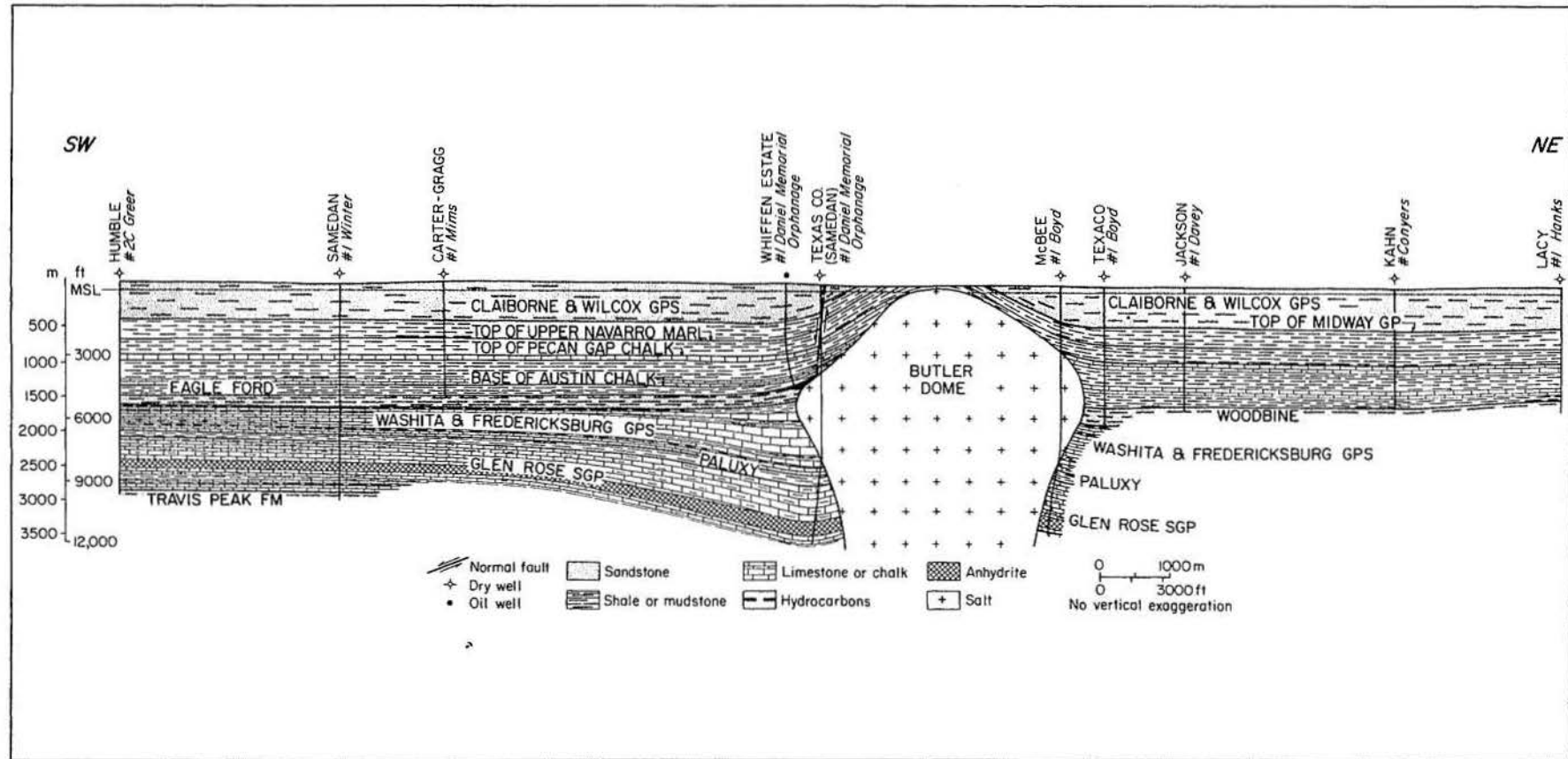

Figure 43. Structural cross section through Butler Dome (Wood and Giles, 1982).

DOME NAME: EAST TYLER

LOCATION:

Central Smith Co.
32° 22' 30" N; 95° 15' 45" W

RESIDUAL GRAVITY EXPRESSION:

-84 G units

DEPTH:

Depth to Cap Rock:

800 ft (244 m)

Depth to Salt Stock:

890 ft (271 m)

Depth to Top of Louann Salt (approximate):

21,000 ft (6,400 m)

ORIENTATION AND MAXIMUM LATERAL DIMENSIONS OF SALT STOCK:

Major Axis:

Length:

3.3 mi (5.3 km)

Orientation:

080°

Minor Axis:

Length:

2.9 mi (4.6 km)

Area:

7.4 mi² (18.9 km²)

Area of Planar Crest:

0.7 mi² (1.8 km²)

Percentage Planar Crest:

9%

SHAPE OF SALT STOCK:

General:

Piercement stock

Plan:

Slightly elliptical (axial ratio = 1.1)

Cross Section:

Axis:

Axial plunge 83°; tilt direction 305°;
tilt distance 520 ft (158 m)

Approximate Overall Symmetry:

Monoclinic

Crest:

Conical-convex, small trough in SE flank

Sides:

Upward diverging from -6,000 ft to -5,000 ft (-1,829 m to -1,524 m) along NE flank; upward converging above -5,000 ft (-1,524 m); deepest data -6,000 ft (-1,829 m) on NE flank, -5,000 ft (-1,524 m) elsewhere

Overhang:

Moderate overhang on NE flank only, insufficient data elsewhere; maximum lateral overhang (on NE flank) 600 ft (183 m); percentage overhang 5% (assuming symmetrical shape)

CAP ROCK:

Maximum Stratigraphic Thickness:

277 ft (84 m)

Minimum Stratigraphic Thickness:

90 ft (27 m)

Composition:

Anhydrite, calcite

GEOMETRY OF ADJOINING STRATA:

Lateral Extent of Rim Syncline:

28,500 ft (8,687 m)

Lateral Extent of Drag Zone:

13,500 ft (4,115 m)

Vertical Variation in Maximum Dip of Strata:

$\Delta = -5^\circ$ at -4,600 ft (-1,402 m) (Woodbine)

$\Delta = 0^\circ$ at -2,500 ft (-762 m)

(upper Navarro Marl)

$\Delta = +15^\circ$ at -1,640 ft (-500 m) (Wilcox)

Angle Between Salt and Surrounding Strata:

$\delta = 130^\circ$ at -6,000 ft (-1,829 m) (Washita)

$\delta = 90^\circ$ at -4,600 ft (-1,402 m) (Woodbine)

$\delta = 20^\circ$ at -1,640 ft (-500 m) (Navarro)

$\delta = 0^\circ$ at +100 ft (+30 m) (Claiborne)

Contact fault below Eagle Ford Group

Oldest Planar Overburden:

Claiborne Group

EAST TYLER DOME (continued)

FAULTING OF ADJACENT STRATA:

Faults at Flanks:

None

Crestal Faults:

Homothetic, normal, up-to-dome on S flank

Youngest Faulted Strata:

Wilcox Group

Oldest Strata at Surface:

Sparta Formation: no stratigraphic evidence of doming at surface

GROWTH HISTORY:

PRIMARY PERIPHERAL SINK:

Age of Initiation:

Pre-110 Ma

Age of Cessation:

Pre-110 Ma

Duration of Growth:

Unknown

Distance of Axial Trace from Center of Dome:

3 to 5 mi (5 to 8 km)

SECONDARY PERIPHERAL SINK:

Age of Initiation:

Pre-110 Ma

Age of Cessation:

90 Ma

TERTIARY PERIPHERAL SINK:

Age of Initiation:

90 Ma

Age of Cessation:

Post-50 Ma

AGE OF MIGRATION OF SINK TO SALT-STOCK CONTACT:

110 Ma

DOME-RELATED UNCONFORMITIES:

None recognized

Evidence of Extrusion and Erosion of Salt:

None recognized

YOUNGEST DEFORMATION:

Fault in Wilcox Group

EVIDENCE OF SUBSIDENCE:

Equivocal

Configuration of Overburden Strata:

Claiborne strata arch over dome crest

Drainage System:

Type 2, central supradomal depression, central centripetal drainage

Sinkholes:

None

Surface Salines:

None

RESOURCES AND USES:

HYDROCARBONS:

Number of Producing Wells:

Current: 0

Total: 0

Production:

Current: 0

Total: 0

Stratigraphic Reservoir:

None

Traps:

None

ROCK SALT:

Not mined

SULFUR:

None

GAS STORAGE:

10 wells for LPG storage

EAST TYLER DOME (continued)

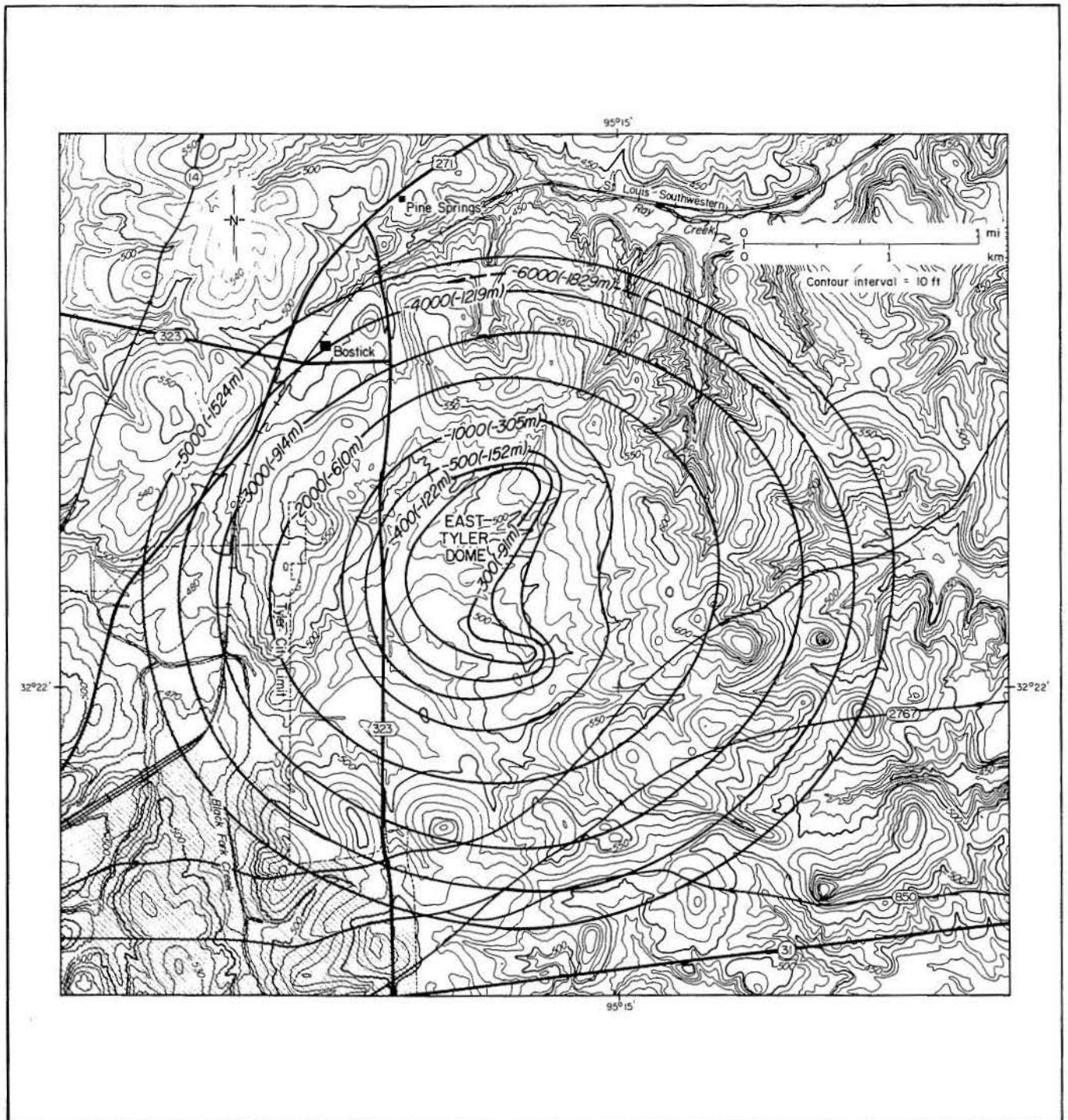

Figure 44. Map showing shape, location, topography, and drainage system of East Tyler Dome (salt structure contours from Giles, 1980).

EAST TYLER DOME (continued)

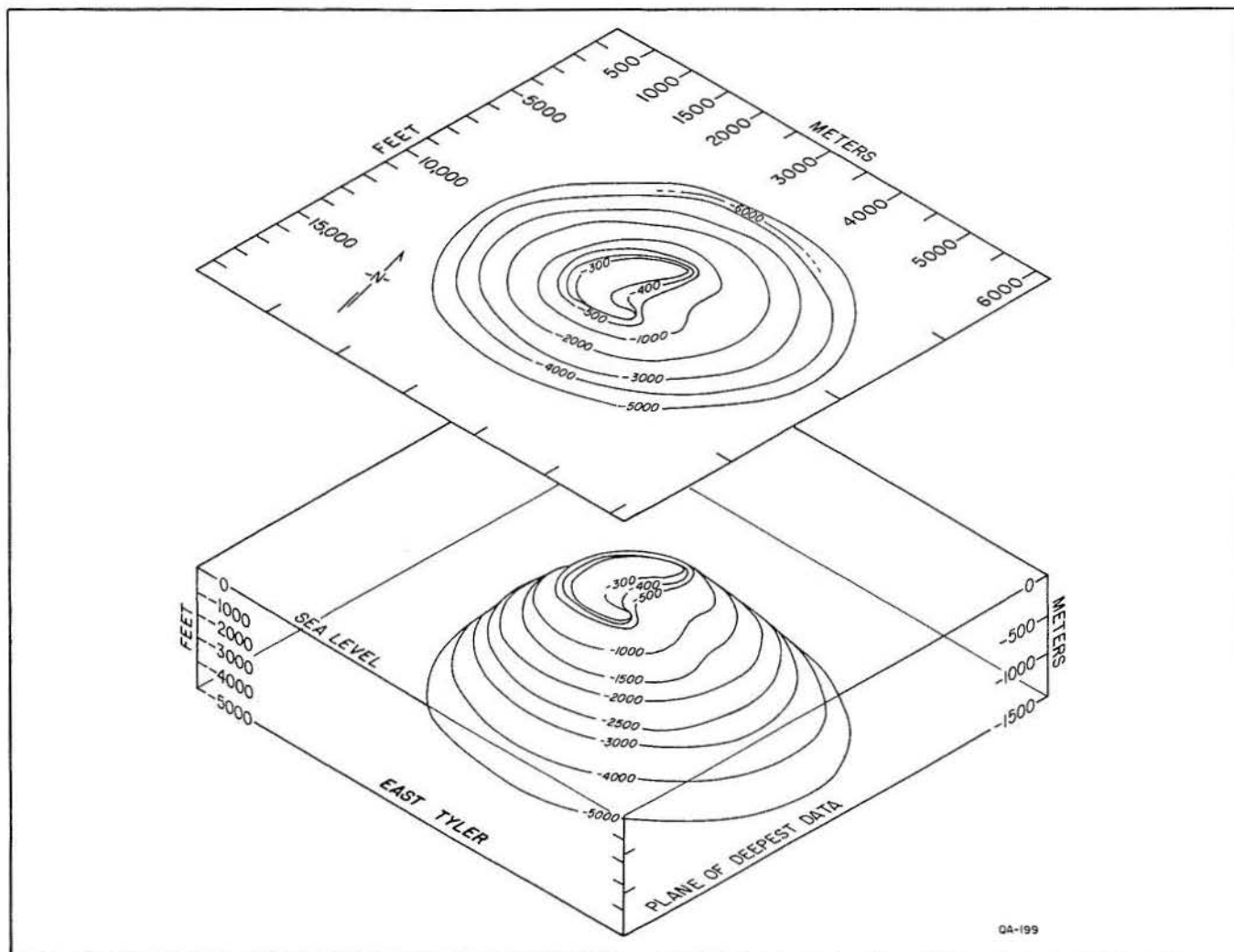

Figure 45. Isometric block diagram of East Tyler salt stock.

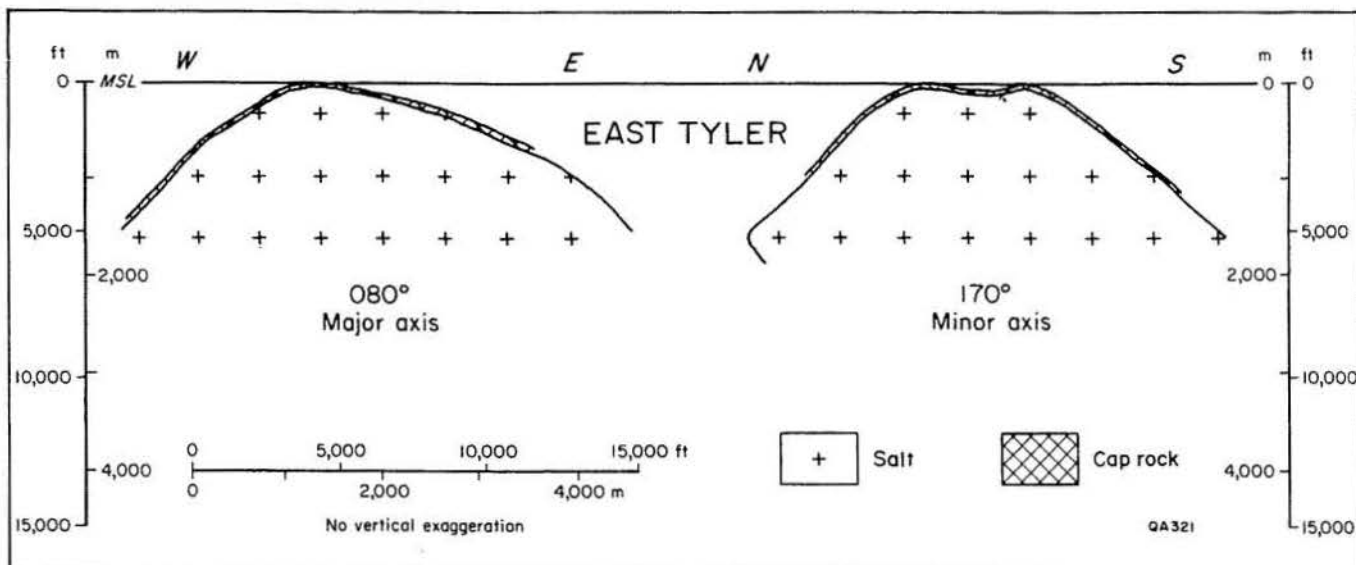

Figure 46. Orthogonal cross sections through major and minor axes of East Tyler salt stock.

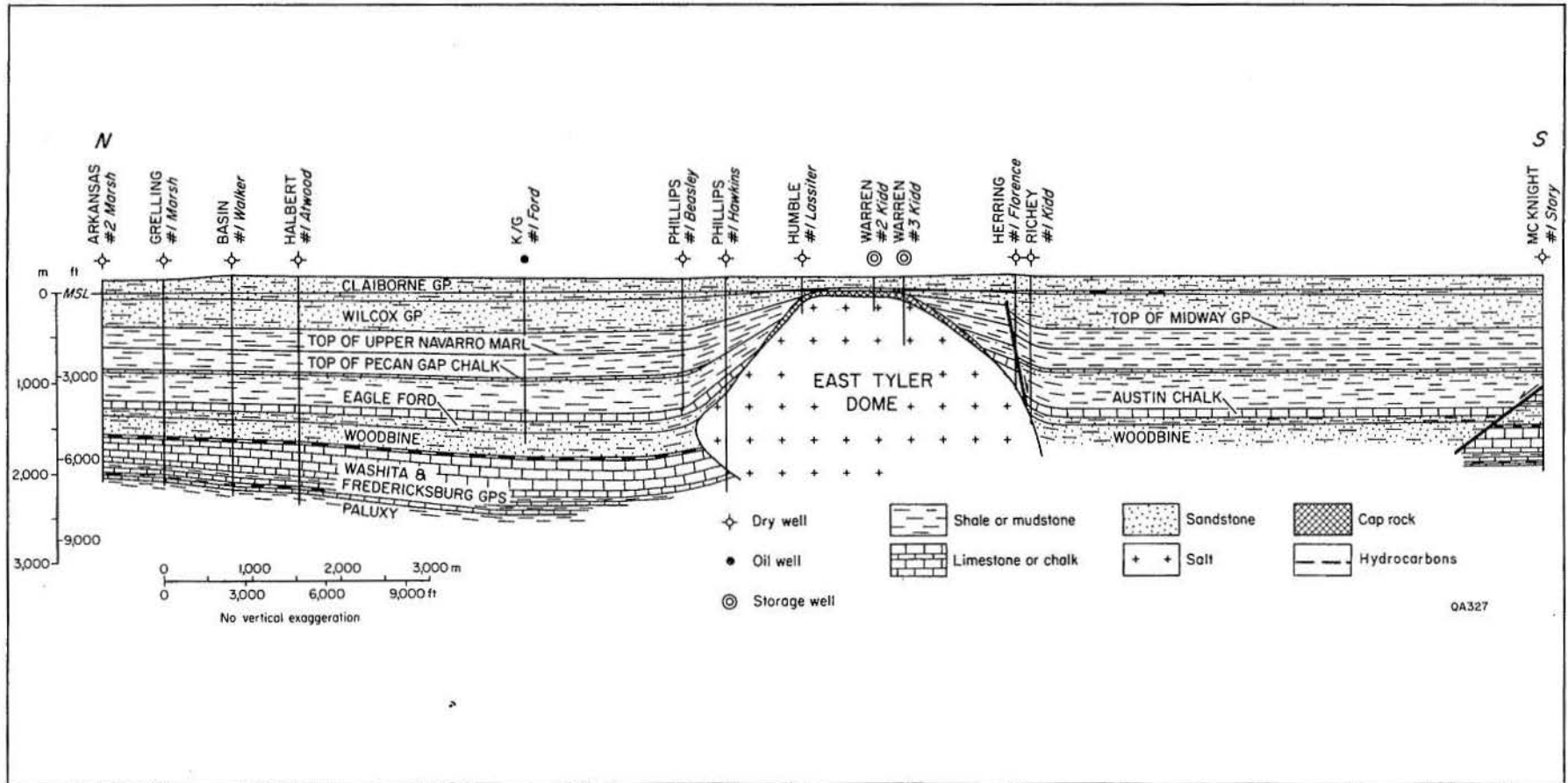

Figure 47. Structural cross section through East Tyler Dome (Giles, 1980).

DOME NAME: GRAND SALINE

LOCATION:

NE Van Zandt Co.
32° 39' 58" N; 95° 42' 34" W

RESIDUAL GRAVITY EXPRESSION:

-56 G units

DEPTH:

Depth to Cap Rock:

171 ft (52 m)

Depth to Salt Stock:

213 ft (65 m)

Depth to Top of Louann Salt (approximate):

20,000 ft (6,100 m)

ORIENTATION AND MAXIMUM LATERAL DIMENSIONS OF SALT STOCK:

Major Axis:

Length:

1.6 mi (2.6 km)

Orientation:

050°

Minor Axis:

Length:

1.5 mi (2.4 km)

Area:

2.1 mi² (5.4 km²)

Area of Planar Crest:

1.8 mi² (4.6 km²)

Percentage Planar Crest:

86%

SHAPE OF SALT STOCK:

General:

Piercement stock

Plan:

Circular (axial ratio = 1.07) at -100 ft (-30 m);
elliptical (axial ratio = 1.3) at -3,000 ft (-914 m)

Cross Section:

Axis:

Axial plunge 74°; tilt direction 339°;
tilt distance 2,112 ft (644 m)

Approximate Overall Symmetry:

Monoclinic

Crest:

Planar

Sides:

Parallel above -7,500 ft (-2,286 m);
deepest data -7,500 ft (-2,286 m)

Overhang:

Minor overhang on SE flank, elevation
-6,500 ft (-1,981 m); maximum lateral
overhang 500 ft (152 m); percentage overhang
10%; axial tilt produces apparent overhang
on NW flank of 2,640 ft (805 m)

CAP ROCK:

Maximum Stratigraphic Thickness:

61 ft (19 m)

Minimum Stratigraphic Thickness:

5 ft (2 m)

Composition:

Anhydrite, gypsum, calcite

GEOMETRY OF ADJOINING STRATA:

Lateral Extent of Rim Syncline:

None above -7,500 ft (-2,286 m)

Lateral Extent of Drag Zone:

21,000 ft (6,401 m)

Vertical Variation in Maximum Dip of Strata:

$\Delta = -5^\circ$ at -6,000 ft (-1,829 m) (Washita)

$\Delta = +5^\circ$ at 0 ft (0 m) (Wilcox)

Angle Between Salt and Surrounding Strata:

$\delta = 85^\circ$ at -8,600 ft (-2,621 m) (Glen Rose)

$\delta = 30^\circ$ at 0 ft (0 m) (Wilcox)

Contact fault below Wilcox Group

Oldest Planar Overburden:

Wilcox Group

FAULTING OF ADJACENT STRATA:

Faults at Flanks:

Small graben on NE flank

Crestal Faults:

None

Youngest Faulted Strata:

Woodbine Group

Oldest Strata at Surface:

Wilcox Group: no stratigraphic evidence of
doming at surface

GRAND SALINE DOME (continued)

GROWTH HISTORY:

PRIMARY PERIPHERAL SINK:

Age of Initiation:

Pre-110 Ma

Age of Cessation:

Pre-110 Ma

Duration of Growth:

Unknown

Distance of Axial Trace from Center of Dome:

3 to 5 mi (5 to 8 km)

SECONDARY PERIPHERAL SINK:

Age of Initiation:

Pre-110 Ma

Age of Cessation:

Unknown

TERTIARY PERIPHERAL SINK:

Age of Initiation:

Pre-110 Ma

Age of Cessation:

Post-50 Ma

AGE OF MIGRATION OF SINK TO SALT-STOCK CONTACT:

100 Ma

DOMES-RELATED UNCONFORMITIES:

None recognized

Evidence of Extrusion and Erosion of Salt:

None recognized

YOUNGEST DEFORMATION:

Unknown

EVIDENCE OF SUBSIDENCE:

Present

Configuration of Overburden Strata:

Wilcox strata lying flat over dome

Drainage System:

Type 2 central supradomal depression, central centripetal drainage

Sinkholes:

Common, central marshy area

Surface Salines:

Present

RESOURCES AND USES:

HYDROCARBONS:

Number of Producing Wells:

Current: 1

Total: 1

Production:

Current: 3,854 bbls

Total: 84,463 bbls

Stratigraphic Reservoir:

Paluxy Formation

Traps:

Flank fault

ROCK SALT:

Mined by underground excavation in Kleer Mine and solution mining

SULFUR:

None

GAS STORAGE:

None

GRAND SALINE DOME (continued)

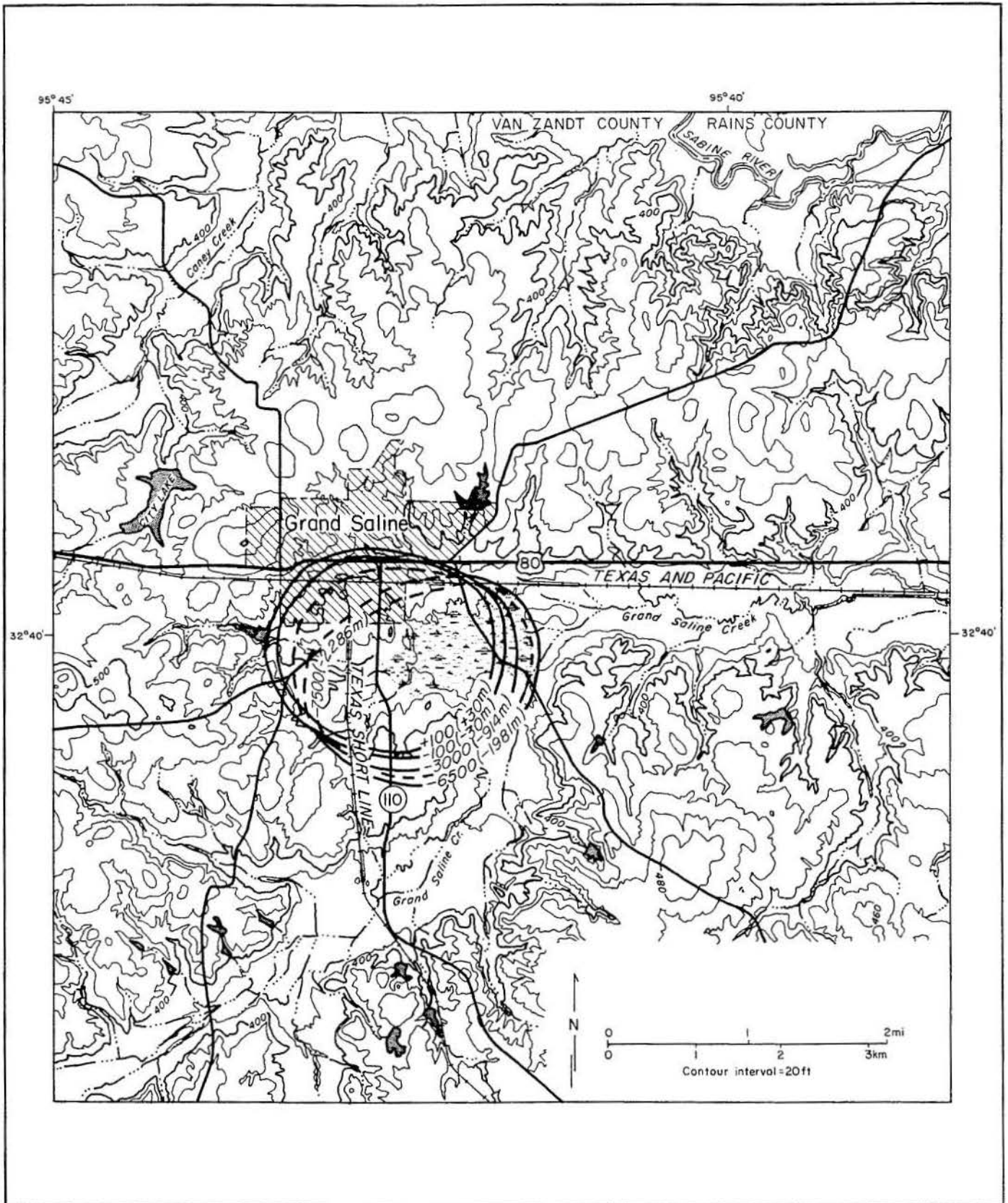

Figure 48. Map showing shape, location, topography, and drainage system of Grand Saline Dome (salt structure contours from Giles, 1980).

GRAND SALINE DOME (continued)

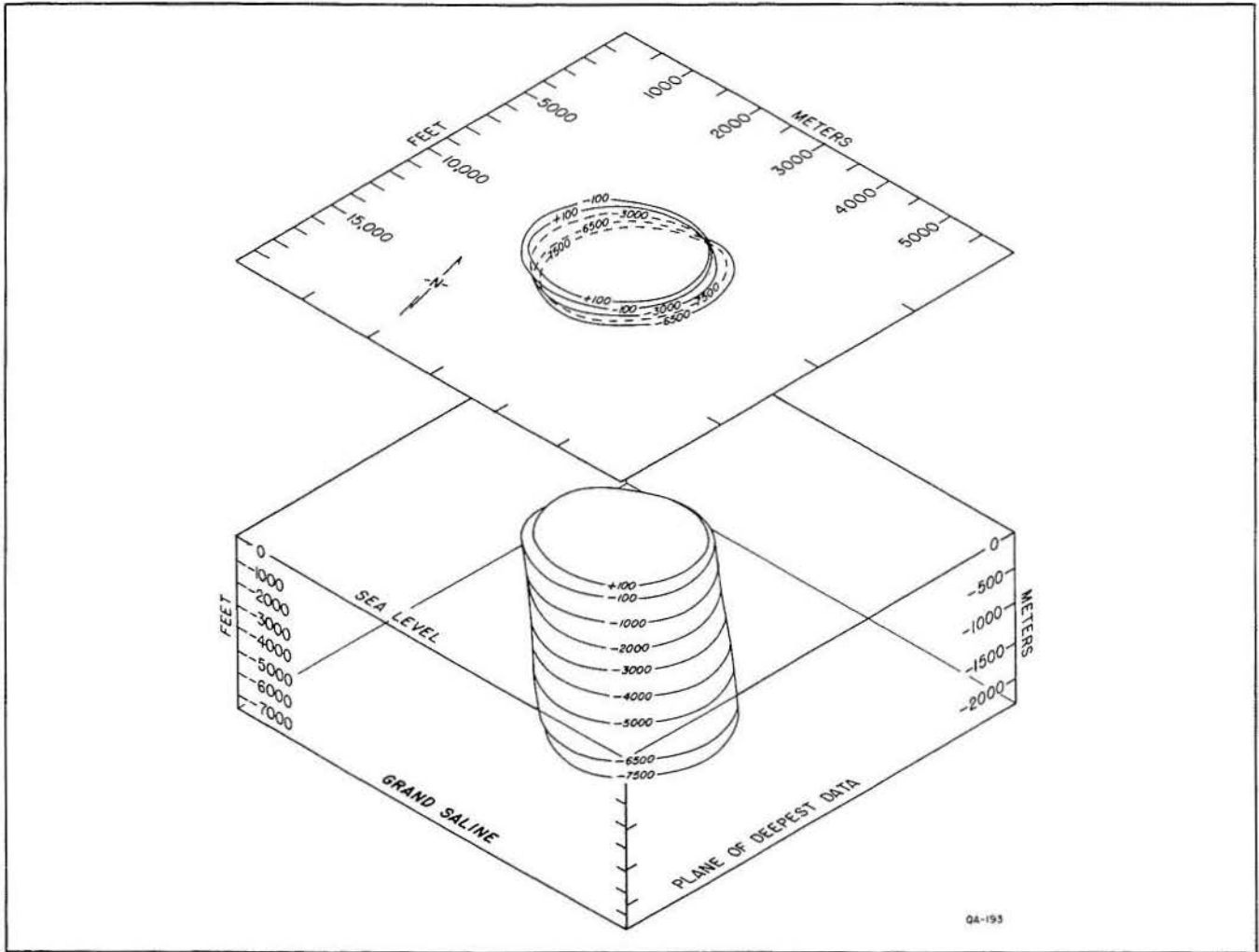

Figure 49. Isometric block diagram of Grand Saline salt stock.

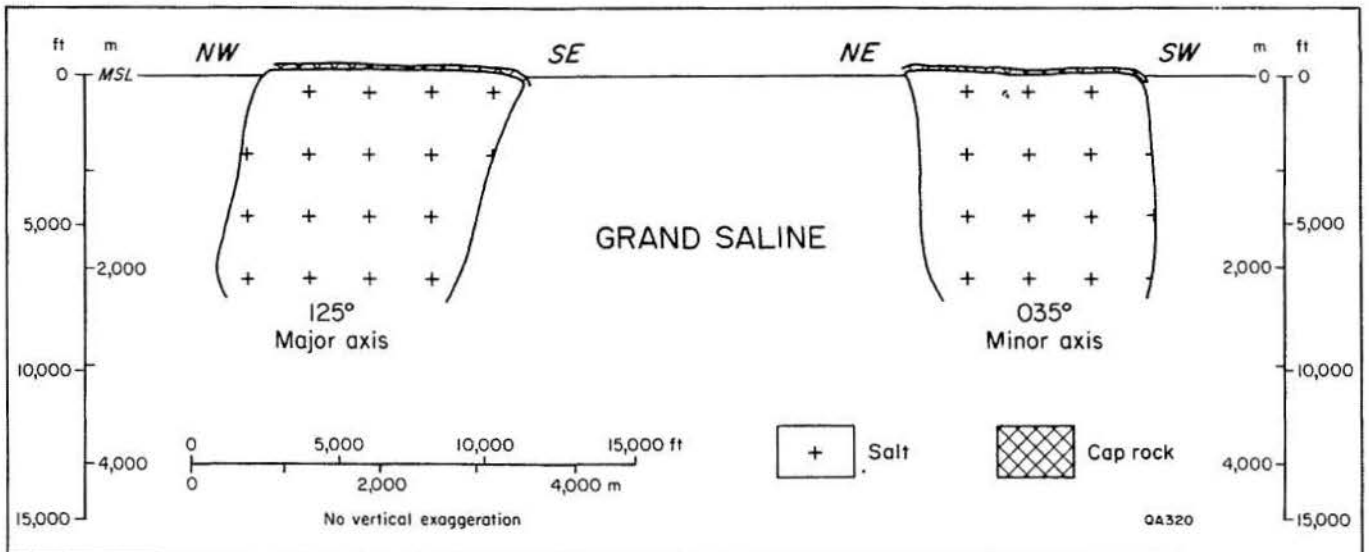

Figure 50. Orthogonal cross sections through major and minor axes of Grand Saline salt stock.

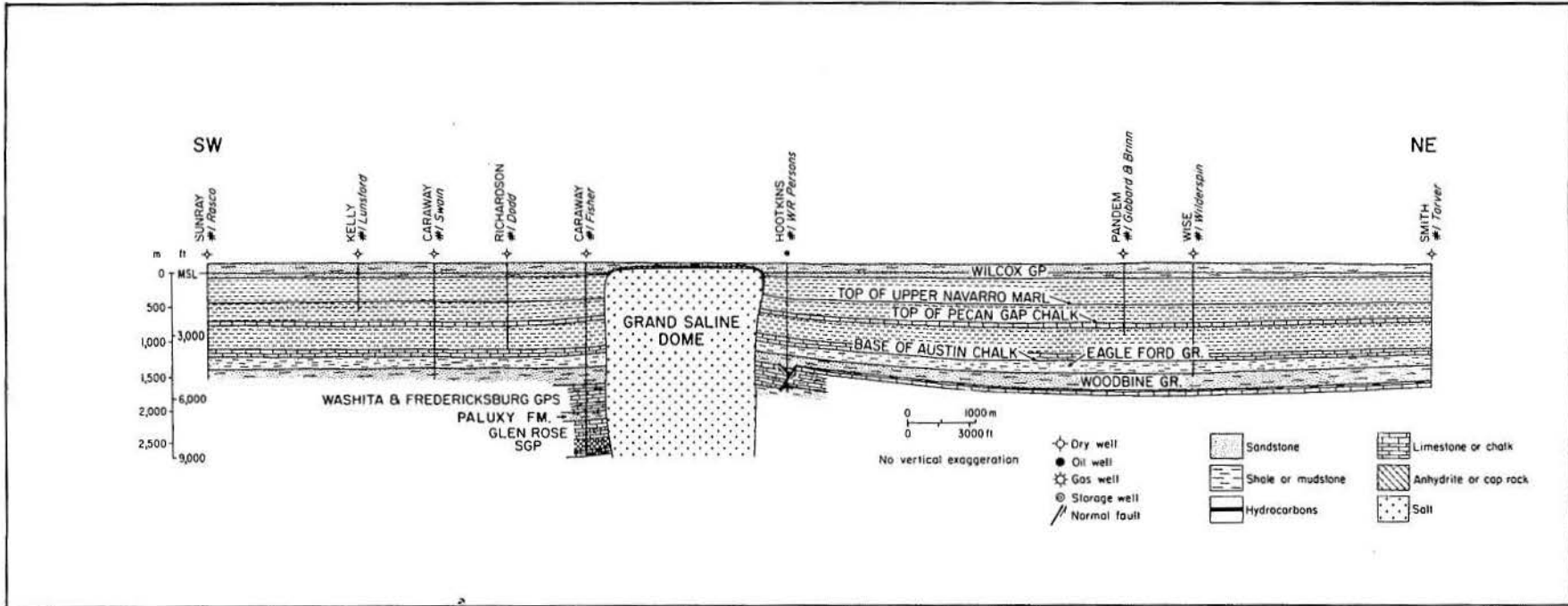

Figure 51. Structural cross section through Grand Saline Dome (Giles and Wood, 1981).

DOME NAME: HAINESVILLE

LOCATION:

South-central Wood Co.
32° 41' 40" N; 95° 22' 20" W

RESIDUAL GRAVITY EXPRESSION:

-110 G units

DEPTH:

Depth to Cap Rock:

1,100 ft (335 m)

Depth to Salt Stock:

1,200 ft (366 m)

Depth to Top of Louann Salt (approximate):

20,000 ft (6,100 m)

ORIENTATION AND MAXIMUM LATERAL DIMENSIONS OF SALT STOCK:

Major Axis:

Length:

4.3 mi (6.9 km)

Orientation:

040°

Minor Axis:

Length:

3.2 mi (5.1 km)

Area:

8.9 mi² (22.8 km²)

Area of Planar Crest:

4.8 mi² (12.3 km²)

Percentage Planar Crest:

54%

SHAPE OF SALT STOCK:

General:

Piercement stock

Plan:

Elliptical (axial ratio = 1.3), small lobes on NE and SW flanks

Cross Section:

Axis:

Vertical

Approximate Overall Symmetry:

Monoclinic

Crest:

Complex

Sides:

Upward converging from -15,000 ft to -10,000 ft (-4,572 m to -3,048 m); upward diverging from -10,000 ft to -4,000 ft (-3,048 m to -1,219 m); upward converging above -4,000 ft (-1,219 m)

Overhang:

Broad, circum-domal, symmetrical, elevation -3,000 ft (-914 m); maximum lateral overhang 8,400 ft (2,560 m) on NE flank; percentage overhang 226%

CAP ROCK:

Maximum Stratigraphic Thickness:

105 ft (32 m)

Minimum Stratigraphic Thickness:

43 ft (13 m)

Composition:

Anhydrite

GEOMETRY OF ADJOINING STRATA:

Lateral Extent of Rim Syncline:

54,000 ft (16,459 m)

Lateral Extent of Drag Zone:

21,000 ft (6,401 m)

Vertical Variation in Maximum Dip of Strata:

$\Delta = -7^\circ$ at -8,000 ft (-2,438 m)
(Woodbine)

$\Delta = 0^\circ$ at -1,500 ft (-457 m) (Wilcox)

$\Delta = +30^\circ$ at -1,200 ft (-366 m) (Wilcox)

Angle Between Salt and Surrounding Strata:

$\delta = 90^\circ$ at -7,500 ft (-2,286 m)
(Austin)

$\delta = 150^\circ$ at -4,000 ft (-1,219 m)
(Pecan Gap)

$\delta = 0^\circ$ at -1,000 ft (-305 m) (Wilcox)

Contact fault below Upper Midway Group

Oldest Planar Overburden:

Claiborne Group

HAINESVILLE DOME (continued)

FAULTING OF ADJACENT STRATA:

Faults at Flanks:

None

Crestal Faults:

None

Evidence of Growth Faulting:

None

Youngest Faulted Strata:

Wilcox Group

Oldest Strata at Surface:

Claiborne Group: no stratigraphic evidence of doming at surface

GROWTH HISTORY:

PRIMARY PERIPHERAL SINK:

Age of Initiation:

Pre-110 Ma

Age of Cessation:

90 Ma

Duration of Growth:

At least 20 Ma

Distance of Axial Trace from Center of Dome:

5 to 7 mi (8 to 12 km)

SECONDARY PERIPHERAL SINK:

Age of Initiation:

90 Ma

Age of Cessation:

60 Ma

TERTIARY PERIPHERAL SINK:

Age of Initiation:

60 Ma

Age of Cessation:

Post-50 Ma

AGE OF MIGRATION OF SINK TO SALT-STOCK CONTACT:

70 Ma

DOME-RELATED UNCONFORMITIES:

Common in Lower and Upper Cretaceous

Evidence of Extrusion and Erosion of Salt:

Unconformities, large volume of salt withdrawn, small volume of salt dissolved to form cap rock (Seni and Jackson, 1983a)

YOUNGEST DEFORMATION:

Faults in Wilcox strata

EVIDENCE OF SUBSIDENCE:

Present

Configuration of Overburden Strata:

Wilcox strata downfaulted over crest of dome

Drainage System:

Type 4, central supradomal depression, transverse drainage

Sinkholes:

None

Surface Salines:

None

RESOURCES AND USES:

HYDROCARBONS:

3 fields: Hainesville, Hainesville Dome, Neuhoff

Number of Producing Wells:

Current:

0 (Hainesville Field); 1 (Hainesville Dome Field); ? (Neuhoff Field)

Total:

1 (Hainesville Field); 2 (Hainesville Dome Field); ? (Neuhoff Field)

Production:

Current

Total

} see chart on next page

Stratigraphic Reservoir:

Woodbine Group, Paluxy Formation (Neuhoff); Hosston Formation (Hainesville Dome); Sub-Clarksville Member (Hainesville)

Traps:

Hosston Formation, all production beneath overhang, associated with possible angular unconformity

ROCK SALT:

Not mined

SULFUR:

None

GAS STORAGE:

3 wells for LPG storage

HAINESVILLE DOME (continued)

	Current oil production (bbl)	Total oil production (bbl)	Current gas production (Mcf)	Total gas production (Mcf)
Hainesville Field:				
Sub-Clarksville	0	0	0	3,882,866
Hainesville Dome Field:				
Hosston	1,038	37,443	0	0
Neuhoff Field:				
Woodbine	311,104	364,440	0	0
Paluxy	4,575	4,575	0	0

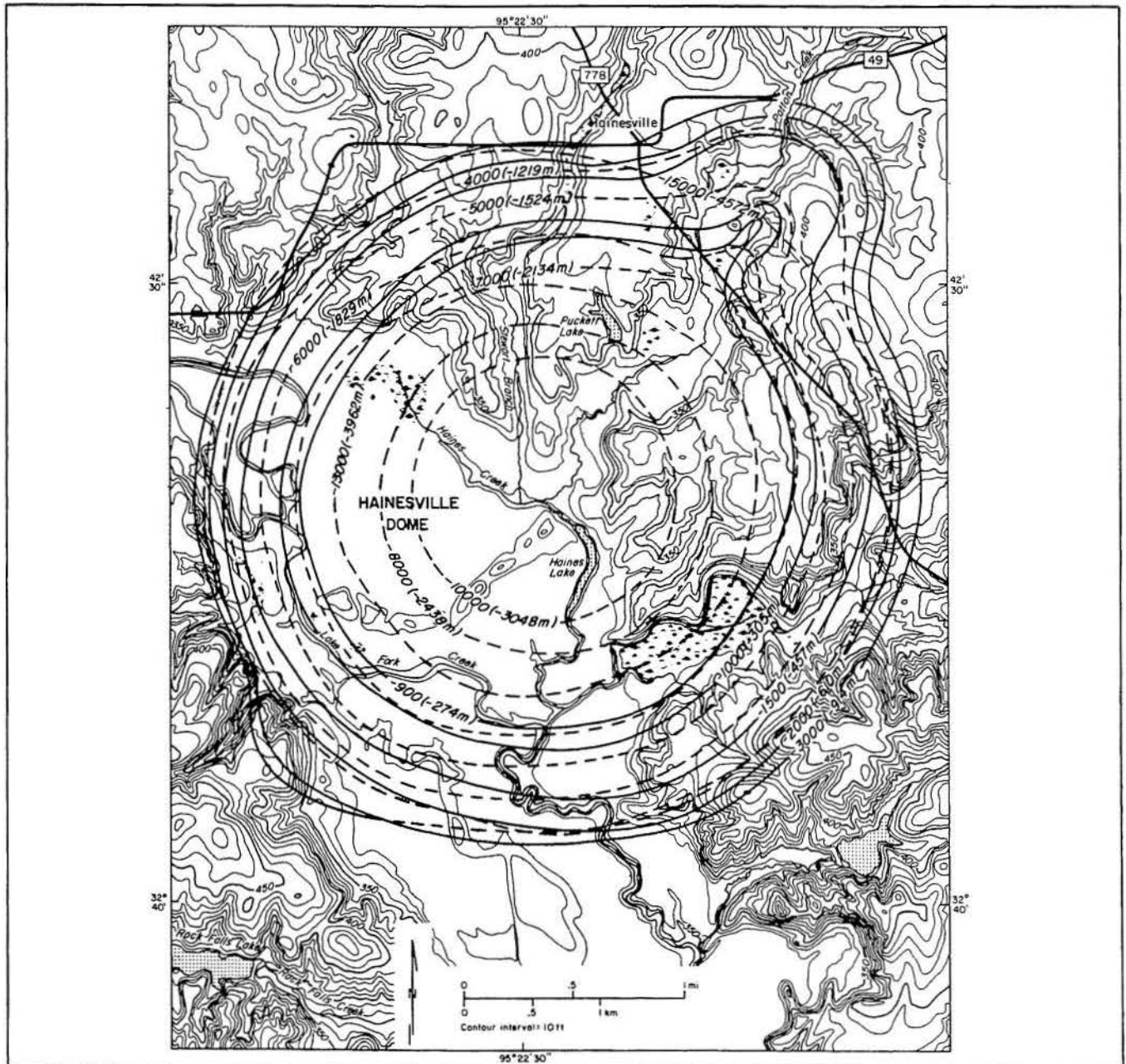

Figure 52. Map showing shape, location, topography, and drainage system of Hainesville Dome (salt structure contours from Giles, 1980).

HAINESVILLE DOME (continued)

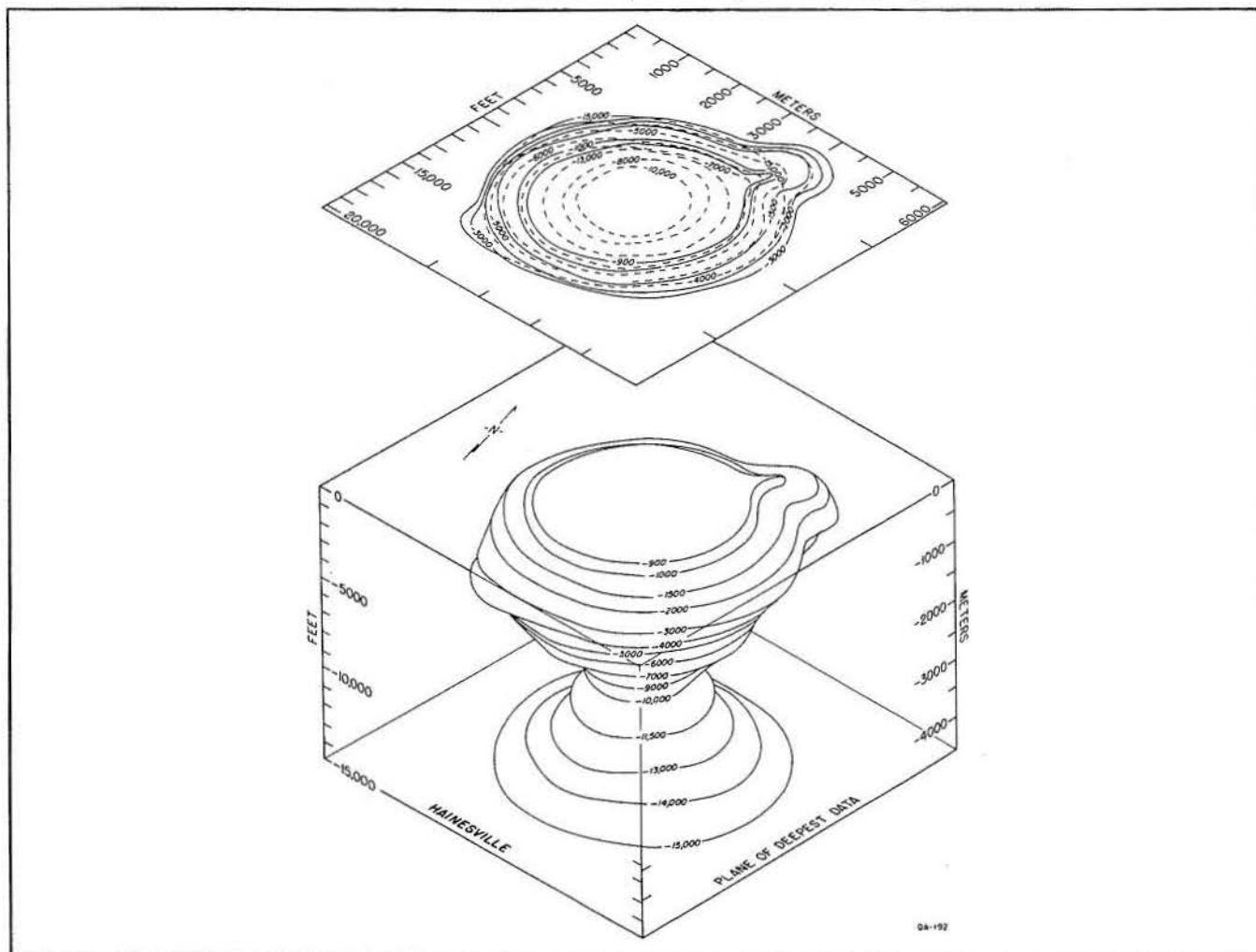

Figure 53. Isometric block diagram of Hainesville salt stock.

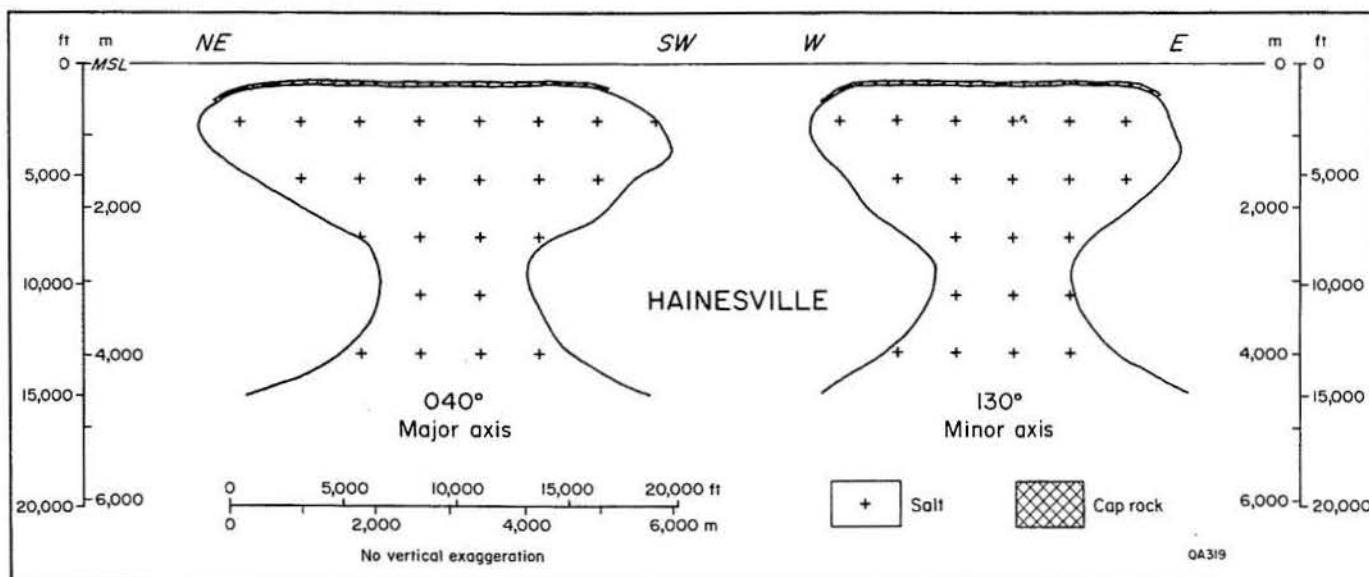

Figure 54. Orthogonal cross sections through major and minor axes of Hainesville salt stock.

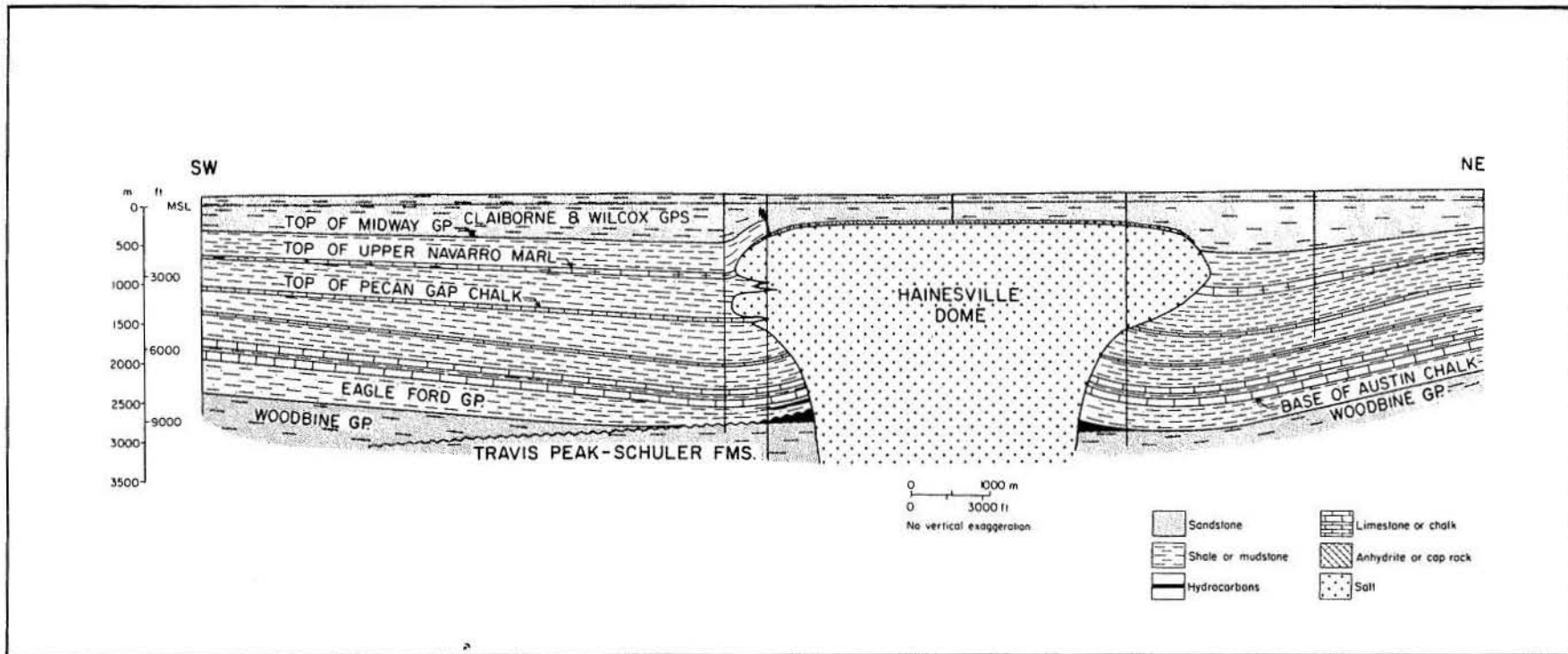

Figure 55. Structural cross section through Hainesville Dome, based on drilling data (Giles and Wood, 1981).

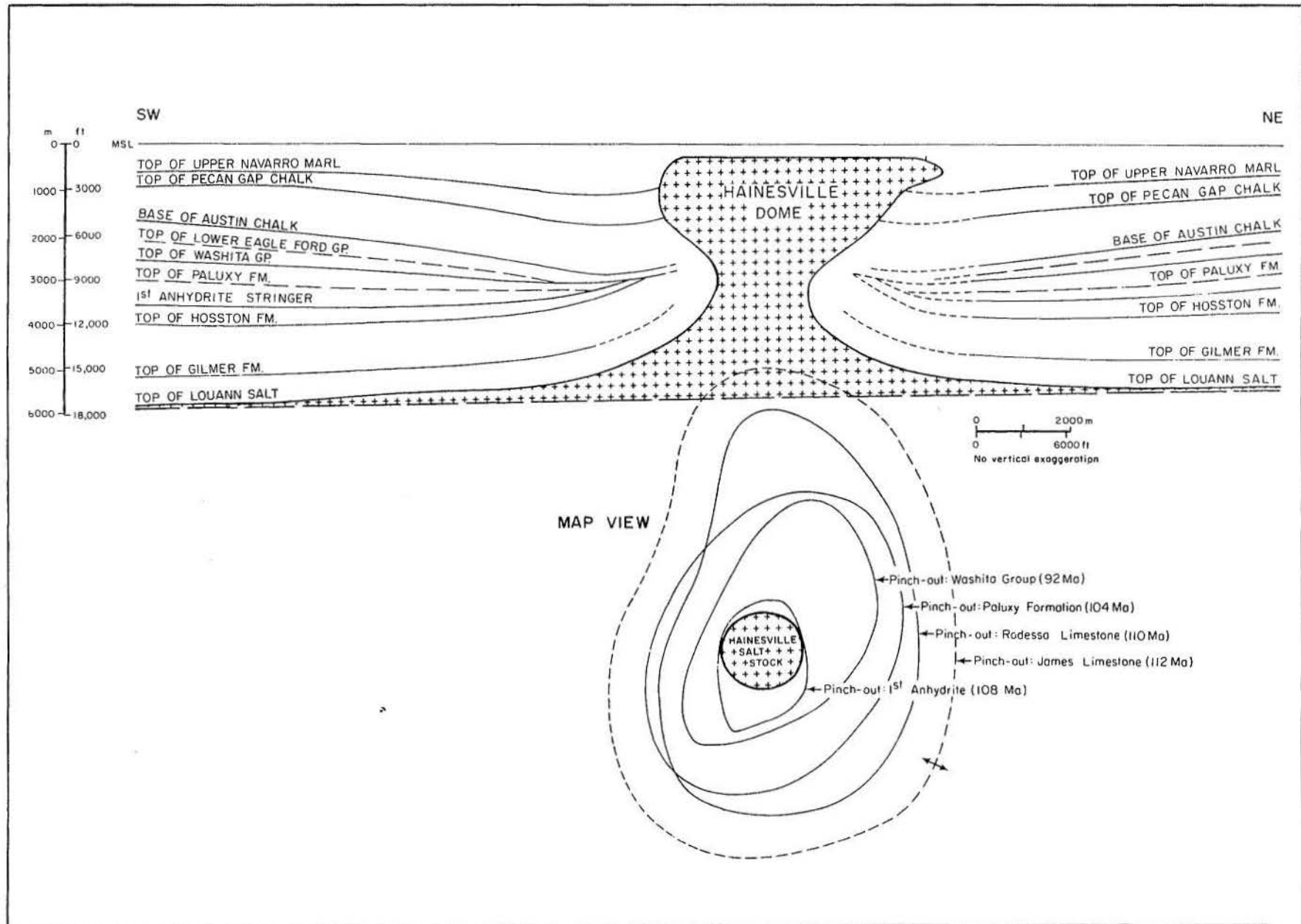

Figure 56. Structural cross section through Hainesville Dome, based on seismic data. (After Loocke, 1978.)

DOME NAME: KEECHI

LOCATION:

Central Anderson Co.
31° 50' 19" N; 95° 42' 20" W

RESIDUAL GRAVITY EXPRESSION:

-128 G units

DEPTH:

Depth to Cap Rock:

250 ft (76 m)

Depth to Salt Stock:

300 ft (91 m)

Depth to Top of Louann Salt (approximate):

21,000 ft (6,400 m)

ORIENTATION AND MAXIMUM LATERAL DIMENSIONS OF SALT STOCK:

Major Axis:

Length:

> 4.6 mi (> 7.4 km)

Orientation:

015°

Minor Axis:

Length:

> 1.7 mi (> 2.7 km)

Area:

> 5.9 mi² (> 15.1 km²)

Area of Planar Crest:

0.2 mi² (0.5 km²)

Percentage Planar Crest:

3%

SHAPE OF SALT STOCK:

General:

Elongate piercement stock

Plan:

Highly elliptical (axial ratio = 2.7)

Cross Section:

Axis:

Axial plunge 8°; tilt direction 059°;
tilt distance 686 ft (209 m)

Approximate Overall Symmetry:

Monoclinic

Crest:

Conical-convex

Sides:

Upward converging above -20,000 ft
(-6,096 m)

Overhang:

Minor overhang on SSE flank, elevation
-2,000 ft (-610 m); maximum lateral
overhang 500 ft (152 m); percentage
overhang ≈ 1%

CAP ROCK:

Maximum Stratigraphic Thickness:

300 ft (91 m)

Minimum Stratigraphic Thickness:

0 ft (0 m)

Composition:

Anhydrite

GEOMETRY OF ADJOINING STRATA:

Lateral Extent of Rim Syncline:

None present above -20,000 ft (-6,096 m)

Lateral Extent of Drag Zone:

30,000 ft (9,144 m)

Vertical Variation in Maximum Dip of Strata:

$\Delta = +20^\circ$ at -4,900 ft (-1,494 m)
(Woodbine)

$\Delta = +10^\circ$ at -1,000 ft (-305 m) (Wilcox)

Angle Between Salt and Surrounding Strata:

$\delta = 65^\circ$ at -2,250 ft (-686 m)

$\delta = 20^\circ$ at -500 ft (-152 m)

Contact fault below Wilcox Group

Oldest Planar Overburden:

Claiborne Group

FAULTING OF ADJACENT STRATA:

Faults at Flanks:

None

Crestal Faults:

Simple graben on N flank, antithetic pair

Youngest Faulted Strata:

Claiborne Group

Oldest Strata at Surface Group:

Taylor-Navarro Groups: stratigraphic evidence
of doming at surface

KEECHI DOME (continued)

GROWTH HISTORY:

PRIMARY PERIPHERAL SINK:

Age of Initiation:

150 Ma

Age of Cessation:

130 Ma

Duration of Growth:

20 Ma

Distance of Axial Trace from Center of Dome:

7 to 8 mi (11 to 13 km)

SECONDARY PERIPHERAL SINK:

Age of Initiation:

130 Ma

Age of Cessation:

120 Ma

TERTIARY PERIPHERAL SINK:

Age of Initiation:

120 Ma

Age of Cessation:

Post-50 Ma

AGE OF MIGRATION OF SINK TO SALT-STOCK CONTACT:

100 Ma

DOMES-RELATED UNCONFORMITIES:

None recognized

Evidence of Extrusion and Erosion of Salt:

None recognized

YOUNGEST DEFORMATION:

Faults through Wilcox Group to surface

EVIDENCE OF SUBSIDENCE:

Present

Configuration of Overburden Strata:

Grabens over dome crest

Drainage System:

Type 4, supradomal depression, transverse drainage

Sinkholes:

None reported

Surface Salines:

present ?

RESOURCES AND USES:

HYDROCARBONS:

Number of Producing Wells:

Current: 0

Total: 0

Production:

Current: 0

Total: 0

Stratigraphic Reservoir:

None

Traps:

None

ROCK SALT:

Not mined

SULFUR:

None

GAS STORAGE:

None

KEECHI DOME (continued)

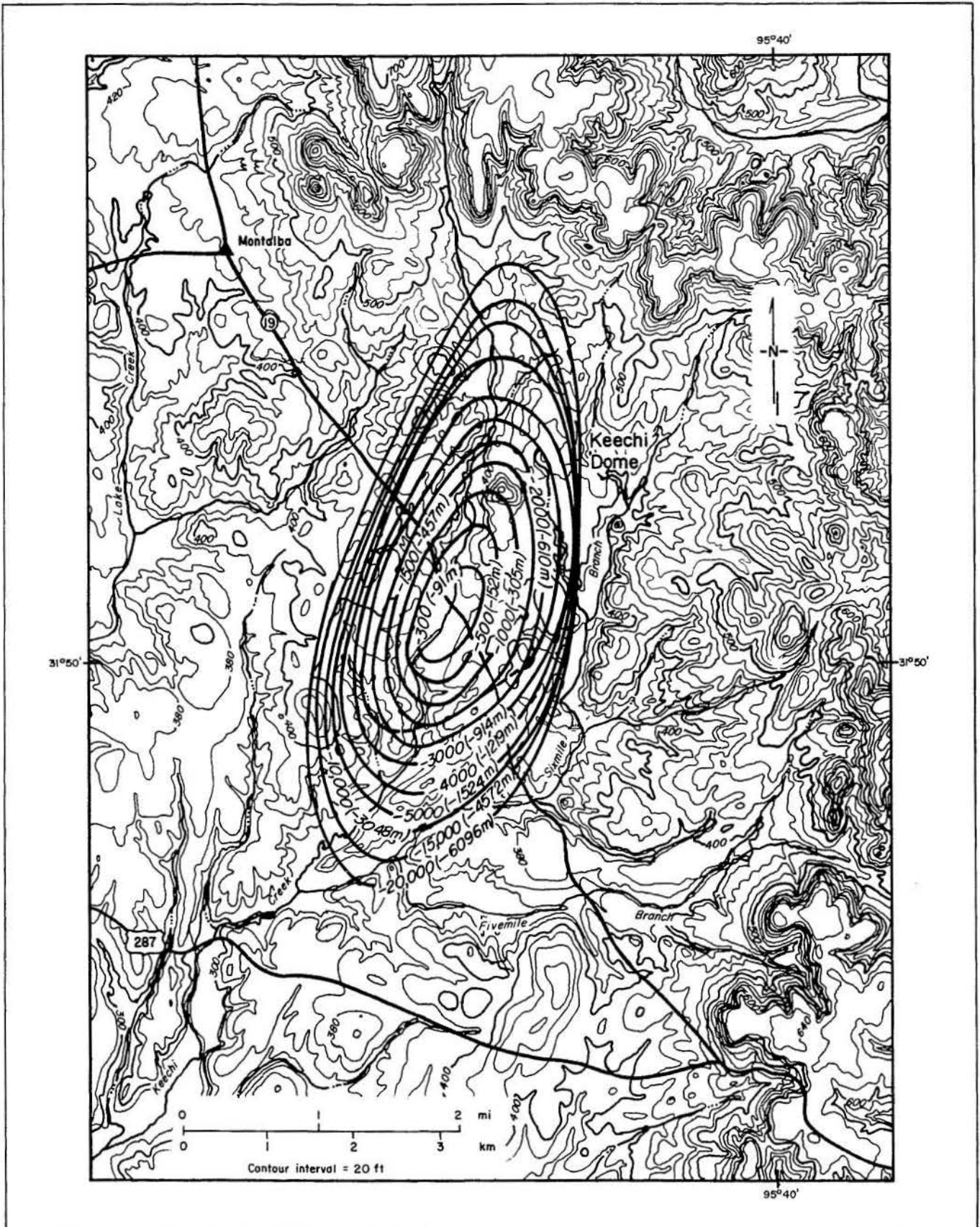

Figure 57. Map showing shape, location, topography, and drainage system of Keechi Dome (salt structure contours modified from Exploration Techniques, 1979).

KEECHI DOME (continued)

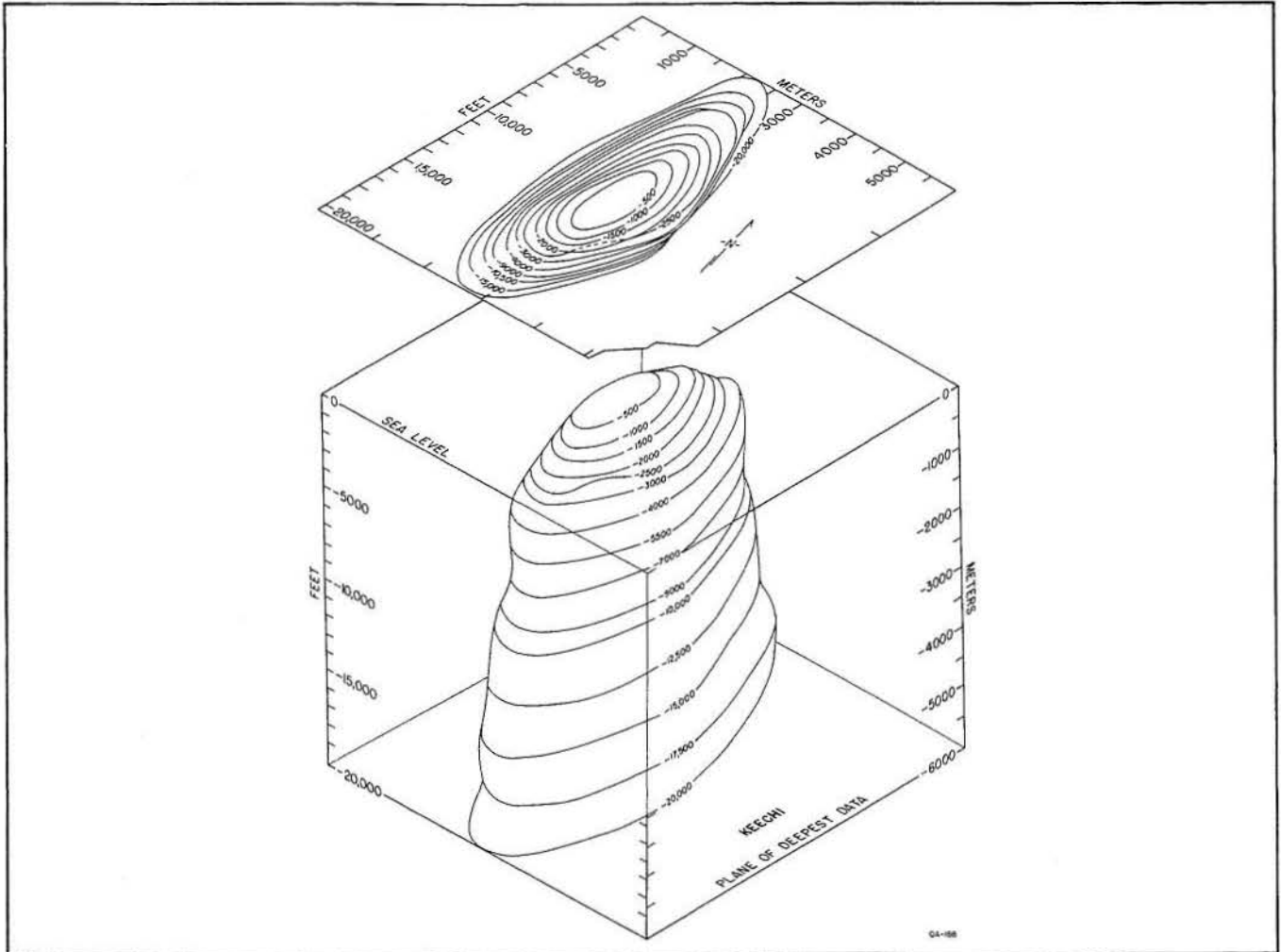

Figure 58. Isometric block diagram of Keechi salt stock.

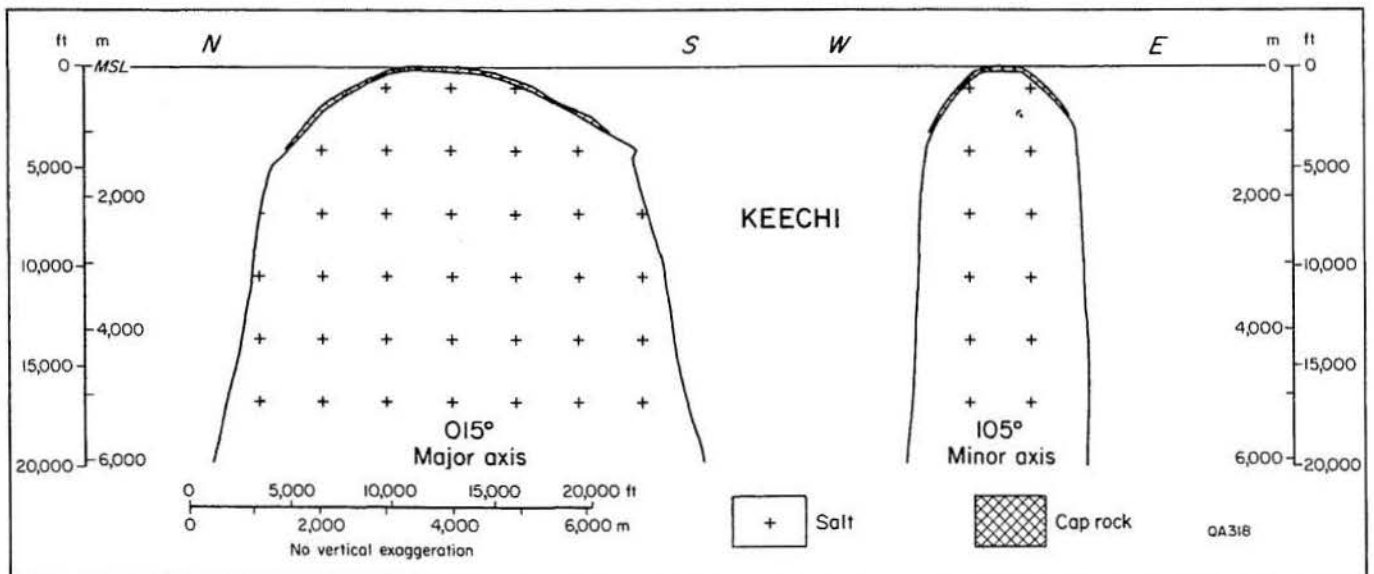

Figure 59. Orthogonal cross sections through major and minor axes of Keechi salt stock.

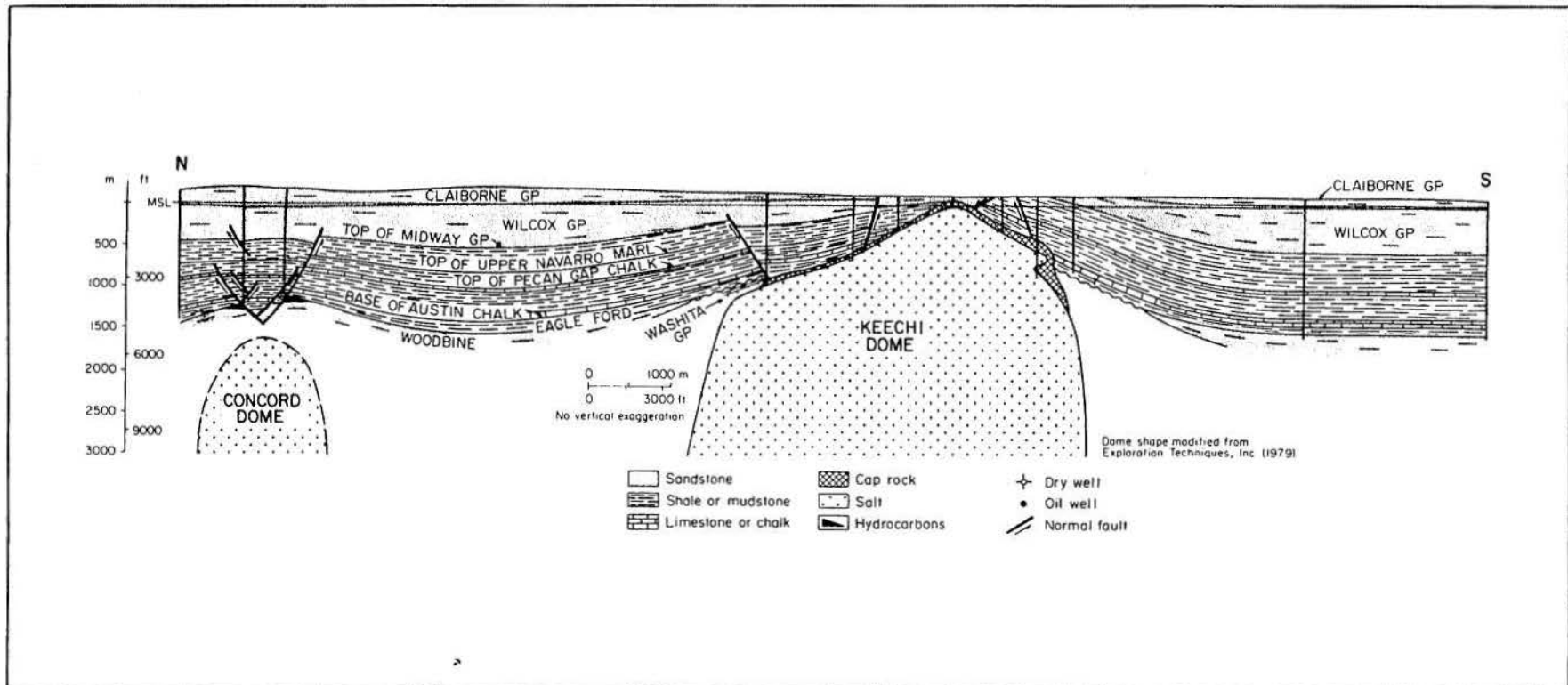

Figure 60. Structural cross section through Keechi Dome and Concord Dome, a deep-diapir area (Giles and Wood, 1981).

DOME NAME: MOUNT SYLVAN

LOCATION:

West-central Smith Co.
32° 23' 09" N; 95° 26' 55" W

RESIDUAL GRAVITY EXPRESSION:

-104 G units

DEPTH:

Depth to Cap Rock:

550 ft (168 m)

Depth to Salt Stock:

613 ft (187 m)

Depth to Top of Louann Salt (approximate):

20,000 ft (6,100 m)

ORIENTATION AND MAXIMUM LATERAL DIMENSIONS OF SALT STOCK:

Major Axis:

Length:

2.3 mi (3.7 km)
at -2,000 ft
(-610 m)

Orientation:

045°

Minor Axis:

Length:

1.5 mi (2.4 km)

Area:

2.5 mi² (6.4 km²)

Area of Planar Crest:

0.3 mi² (0.8 km²)

Percentage Planar Crest:

12%

SHAPE OF SALT STOCK:

General:

Piercement stock

Plan:

Irregular; circular (axial ratio = 1.0) at -18,000 ft (-5,486 m); irregular elliptical (axial ratio = 1.53) at -2,000 ft (-610 m)

Cross Section:

Axis:

Axial plunge 61°; tilt direction 211°;
tilt distance 10,000 ft (3,048 m)

Approximate Overall Symmetry:

Triclinic

Crest:

Complex

Sides:

Upward converging from -18,000 ft to -10,000 ft (-5,486 m to -3,048 m); upward diverging from -10,000 ft to -6,000 ft (-3,048 m to -1,829 m); upward converging above -6,000 ft (-1,829 m)

Overhang:

Multiple overhangs; major, circumdomal, near symmetrical, elevation -6,000 ft (-1,829 m), maximum lateral overhang 3,300 ft (1,006 m) on NE flank, percentage overhang 64%. Minor overhangs, asymmetrical, SW flank only, elevation -2,000 ft (-610 m), maximum lateral overhang 2,000 ft (610 m), percentage overhang 12%; axial tilt produces apparent overhang on SW flank of 10,000 ft (3,048 m)

CAP ROCK:

Maximum Stratigraphic Thickness:

112 ft (34 m)

Minimum Stratigraphic Thickness:

60 ft (18 m)

Composition:

Calcite, anhydrite

GEOMETRY OF ADJOINING STRATA:

Lateral Extent of Rim Syncline:

25,500 ft (7,772 m)

Lateral Extent of Drag Zone:

13,500 ft (4,115 m)

Vertical Variation in Maximum Dip of Strata:

$\Delta = -7^\circ$ at -7,500 ft (-2,286 m) (Paluxy)

$\Delta = 0^\circ$ at -1,500 ft (-457 m) (Wilcox)

$\Delta = +20^\circ$ at -1,000 ft (-305 m) (Wilcox)

Angle Between Salt and Surrounding Strata:

$\delta = 135^\circ$ at -7,500 ft (-2,286 m) (Paluxy)

$\delta = 45^\circ$ at -4,000 ft (-1,219 m) (Austin)

$\delta = 20^\circ$ at 0 ft (0 m) (Wilcox)

Contact fault below Claiborne Group

Oldest Planar Overburden:

Quaternary strata

MOUNT SYLVAN DOME (continued)

FAULTING OF ADJACENT STRATA:

Faults at Flanks:

SE flank, normal, antithetic faults, multiple offset, down-to-dome

Crestal Faults:

None

Evidence of Growth Faulting:

None

Youngest Faulted Strata:

Wilcox Group

Oldest Strata at Surface:

Queen City Formation: no stratigraphic evidence of doming at surface

GROWTH HISTORY:

PRIMARY PERIPHERAL SINK:

Age of Initiation:

150 Ma

Age of Cessation:

130 Ma

Duration of Growth:

20 Ma

Distance of Axial Trace from Center of Dome:

4 to 5 mi (6 to 8 km)

SECONDARY PERIPHERAL SINK:

Age of Initiation:

130 Ma

Age of Cessation:

70 Ma

TERTIARY PERIPHERAL SINK:

Age of Initiation:

70 Ma

Age of Cessation:

Post-50 Ma

AGE OF MIGRATION OF SINK TO SALT-STOCK CONTACT:

110 Ma

DOME-RELATED UNCONFORMITIES:

None recognized

Evidence of Extrusion and Erosion of Salt:

None recognized

YOUNGEST DEFORMATION:

Faults in Wilcox Group

EVIDENCE OF SUBSIDENCE:

Present

Configuration of Overburden Strata:

Wilcox strata arch over dome; half grabens over SE flank

Drainage System:

Type 4, transverse drainage

Sinkholes:

None

Surface Salines:

None

RESOURCES AND USES:

HYDROCARBONS:

Number of Producing Wells:

Current: 0

Total: 0

Production:

Current: 0

Total: 0

Stratigraphic Reservoir:

None

Traps:

None

ROCK SALT:

Not mined

SULFUR:

None

GAS STORAGE:

None

MOUNT SYLVAN DOME (continued)

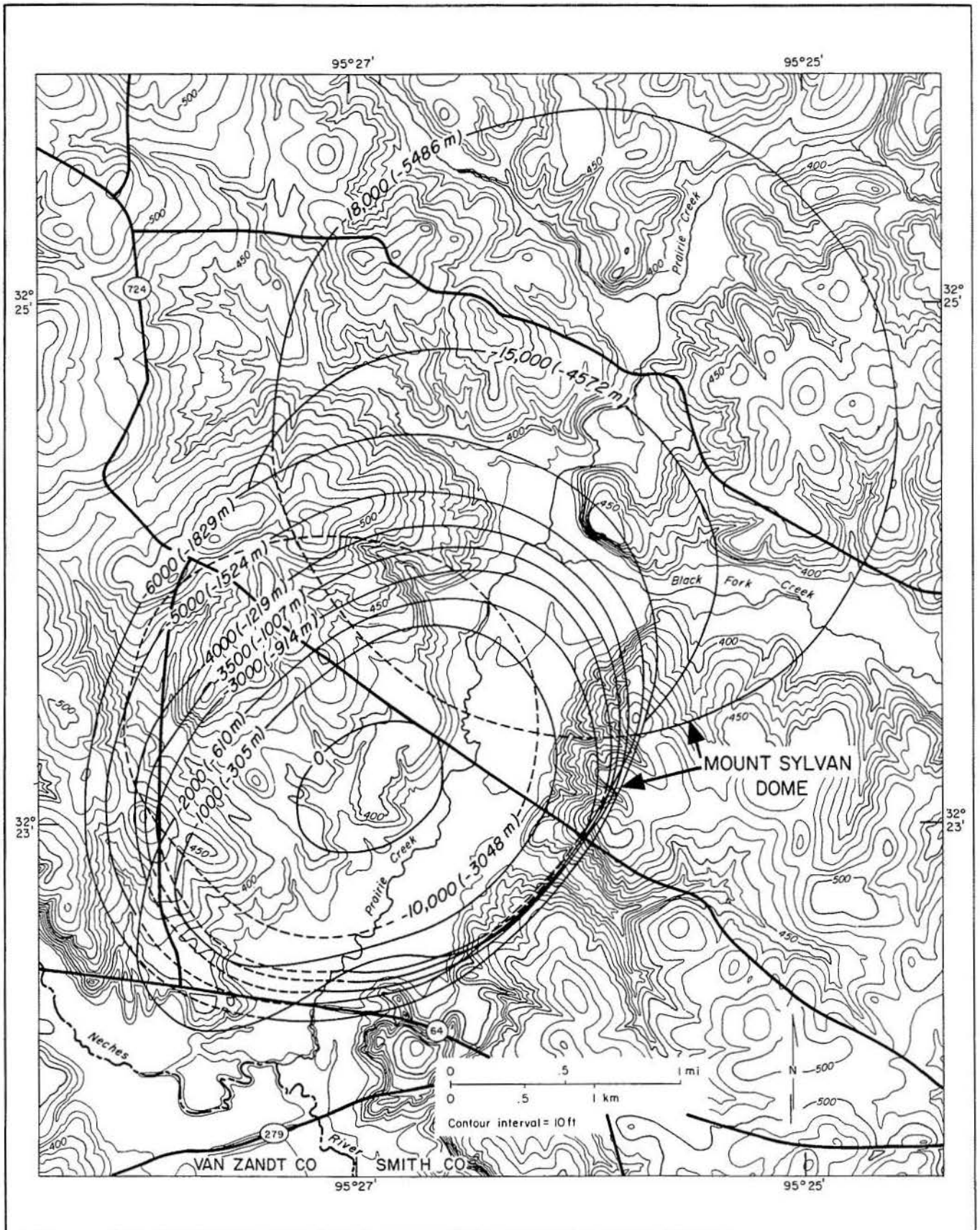

Figure 61. Map showing shape, location, topography, and drainage system of Mount Sylvan Dome (salt structure contours modified from Netherland, Sewell and Associates, 1981).

MOUNT SYLVAN DOME (continued)

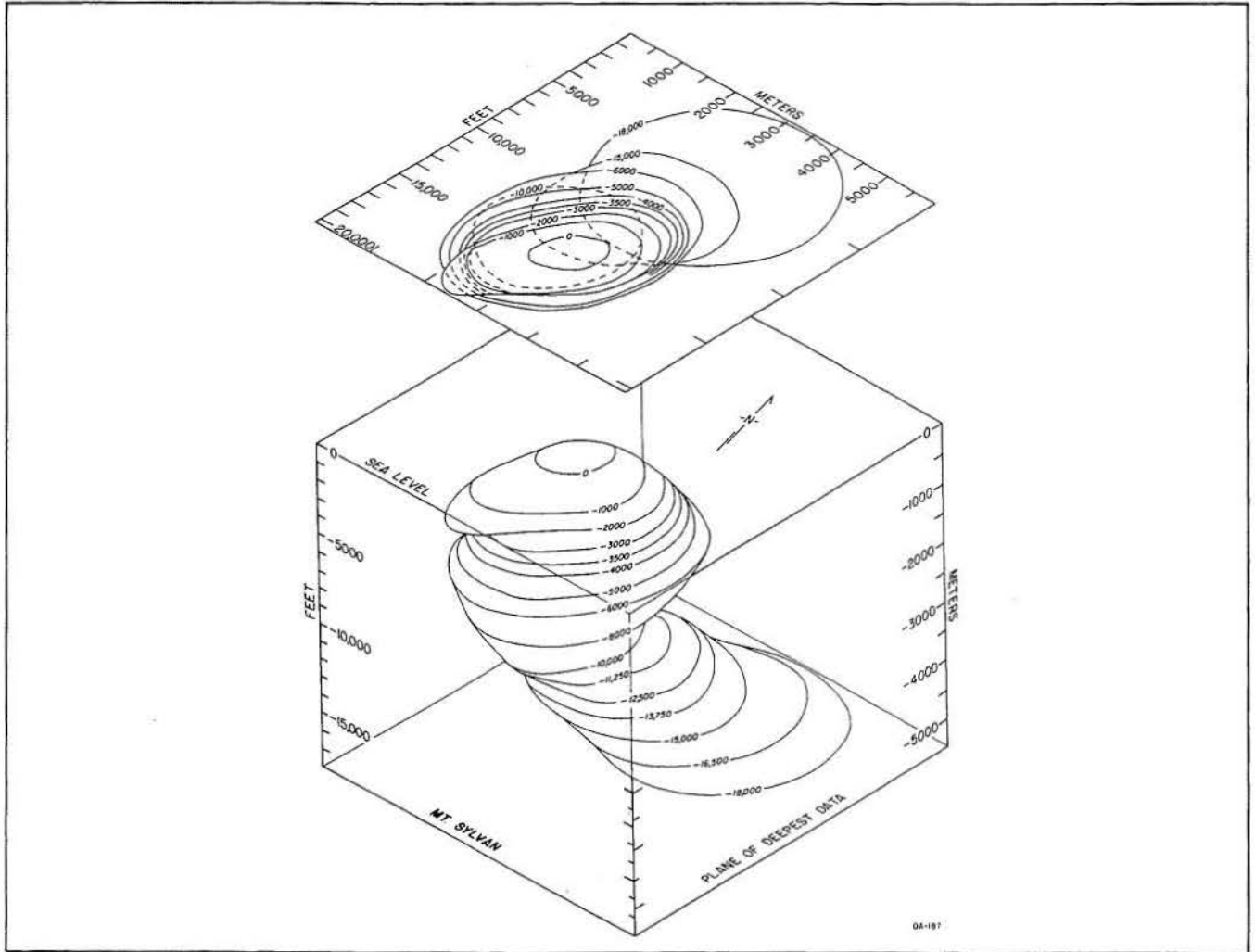

Figure 62. Isometric block diagram of Mount Sylvan salt stock.

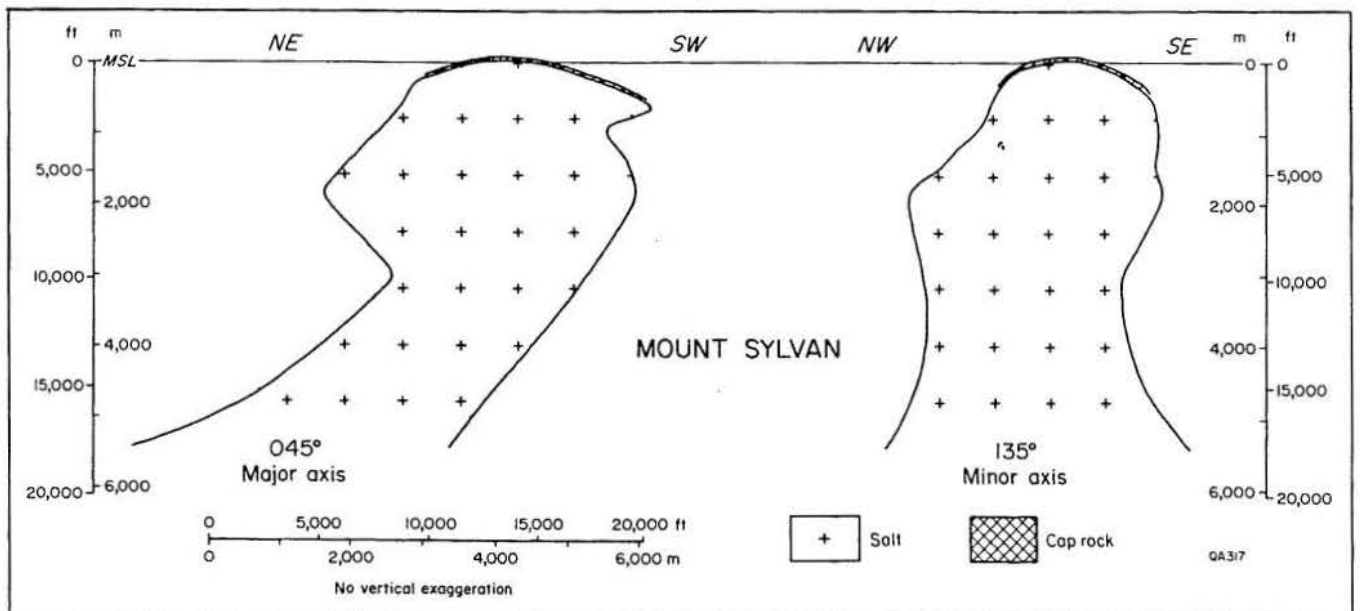

Figure 63. Orthogonal cross sections through major and minor axes of Mount Sylvan salt stock.

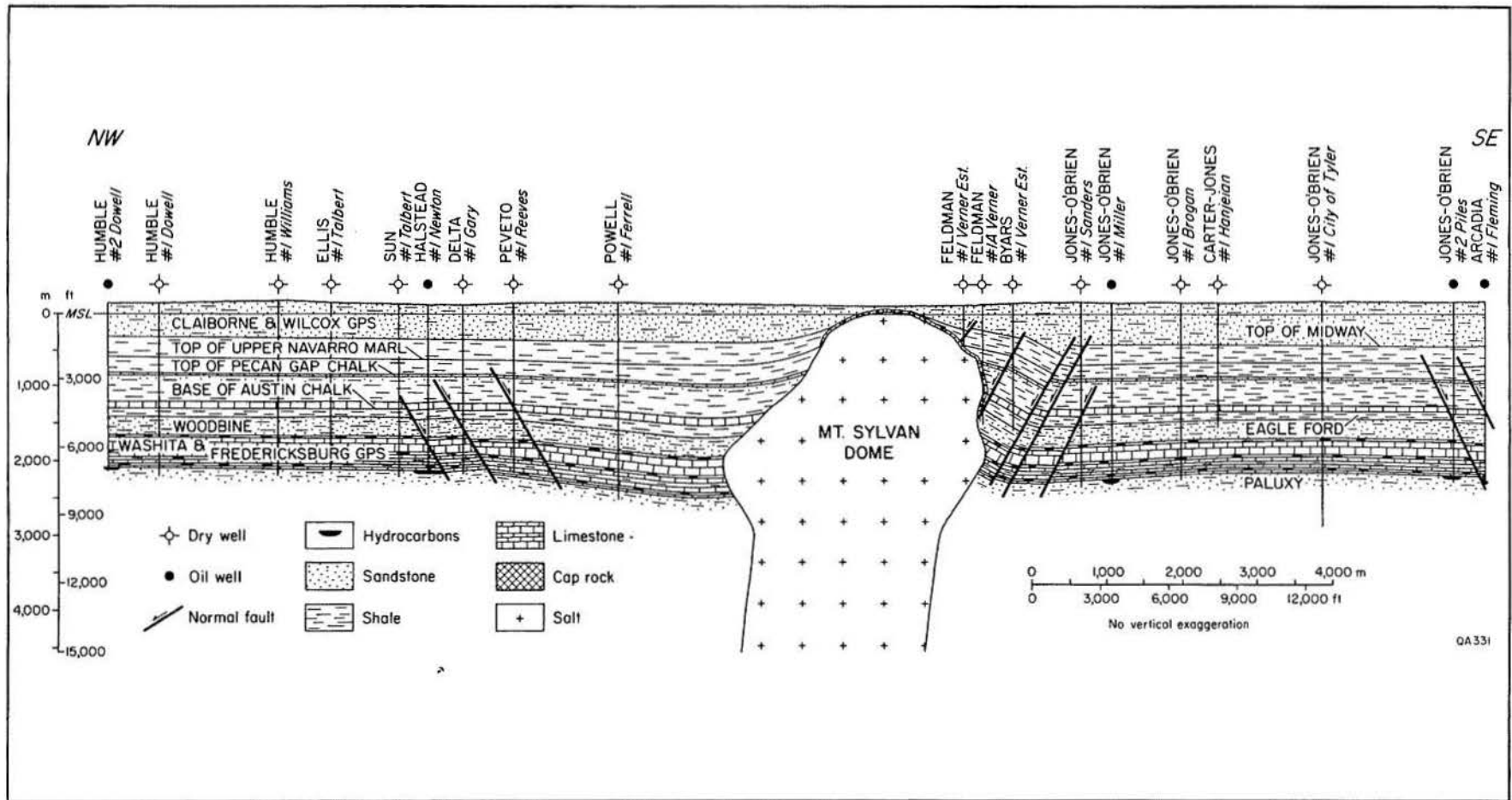

Figure 64. Structural cross section through Mount Sylvan Dome (Giles, 1980).

DOME NAME: OAKWOOD

LOCATION:

SE Freestone Co., north-central Leon Co.
31° 32' 10" N; 95° 58' 13" W

RESIDUAL GRAVITY EXPRESSION:

-48 G units

DEPTH:

Depth to Cap Rock:

703 ft (214 m)

Depth to Salt Stock:

800 ft (244 m)

Depth to Top of Louann Salt (approximate):

20,000 ft (6,100 m)

ORIENTATION AND MAXIMUM LATERAL DIMENSIONS OF SALT STOCK:

Major Axis:

Length:

2.5 mi (4.0 km)

Orientation:

120°

Minor Axis:

Length:

2.0 mi (3.2 km)

Area:

3.8 mi² (9.7 km²)

Area of Planar Crest:

2.8 mi² (7.2 km²)

Percentage Planar Crest:

74%

SHAPE OF SALT STOCK:

General:

Piercement stock

Plan:

Irregular elliptical (axial ratio = 1.24)

Cross Section:

Axis:

Vertical

Approximate Overall Symmetry:

Monoclinic

Crest:

Complex

Sides:

Parallel from -18,000 ft to -10,000 ft
(-5,486 m to 3,048 m); upward diverging
from -10,000 ft to -2,000 ft
(-3,048 m to -610 m); upward converging
above -2,000 ft (-610 m)

Overhang:

Well-developed, circum-domal, symmetrical,
elevation -2,000 ft (-610 m); maximum
lateral overhang 3,600 ft (1,097 m) on NW
flank; percentage overhang 102%

CAP ROCK:

Maximum Stratigraphic Thickness:

533 ft (162 m), thickest at center of
dome crest

Minimum Stratigraphic Thickness:

50 ft (15 m)

Composition:

Anhydrite, calcite

GEOMETRY OF ADJOINING STRATA:

Lateral Extent of Rim Syncline:

22,500 ft (6,858 m)

Lateral Extent of Drag Zone:

13,500 ft (4,115 m)

Vertical Variation in Maximum Dip of Strata:

$\Delta = -3^\circ$ at -5,600 ft (-1,707 m) (Woodbine)

$\Delta = 0^\circ$ at -1,500 ft (-457 m) (Wilcox)

$\Delta = +25^\circ$ at -1,300 ft (-396 m) (Wilcox)

$\Delta = +6^\circ$ at -250 ft (-76 m) (Claiborne)

Angle Between Salt and Surrounding Strata:

$\delta = 90^\circ$ at -16,500 ft (-5,029 m) to crest

Contact fault below Wilcox Group

Oldest Planar Overburden:

Quaternary strata

FAULTING OF ADJACENT STRATA:

Faults at Flanks:

Normal, single offset

Crestal Faults:

Small, central graben, antithetic

Youngest Faulted Strata:

Queen City Formation

OAKWOOD DOME (continued)

Oldest Strata at Surface:

Carrizo Formation: no stratigraphic evidence of doming at surface

GROWTH HISTORY:

PRIMARY PERIPHERAL SINK:

Age of Initiation:

150 Ma

Age of Cessation:

130 Ma

Duration of Growth:

20 Ma

Distance of Axial Trace from Center of Dome:

7 mi (11 km)

SECONDARY PERIPHERAL SINK:

Age of Initiation:

130 Ma

Age of Cessation:

120 Ma

TERTIARY PERIPHERAL SINK:

Age of Initiation:

120 Ma

Age of Cessation:

Post-50 Ma

AGE OF MIGRATION OF SINK TO SALT-STOCK CONTACT:

100 Ma

DOME-RELATED UNCONFORMITIES:

None recognized

Evidence of Extrusion and Erosion of Salt:

None recognized

YOUNGEST DEFORMATION:

Fault in Claiborne Group

EVIDENCE OF SUBSIDENCE:

Absent

Configuration of Overburden Strata:

Claiborne strata arched over dome

Drainage System:

Type 3, supradomal depression, subcentripetal drainage

Sinkholes:

None

Surface Salines:

None

RESOURCES AND USES:

HYDROCARBONS:

Number of Producing Wells:

Current: 2

Total: 24

Production:

Current: 5,004 bbl

Total: 2,120,719 bbl

Stratigraphic Reservoir:

Woodbine Group

Trap:

Beneath overhang

ROCK SALT:

Not mined

SULFUR:

None

GAS STORAGE:

None

OAKWOOD DOME (continued)

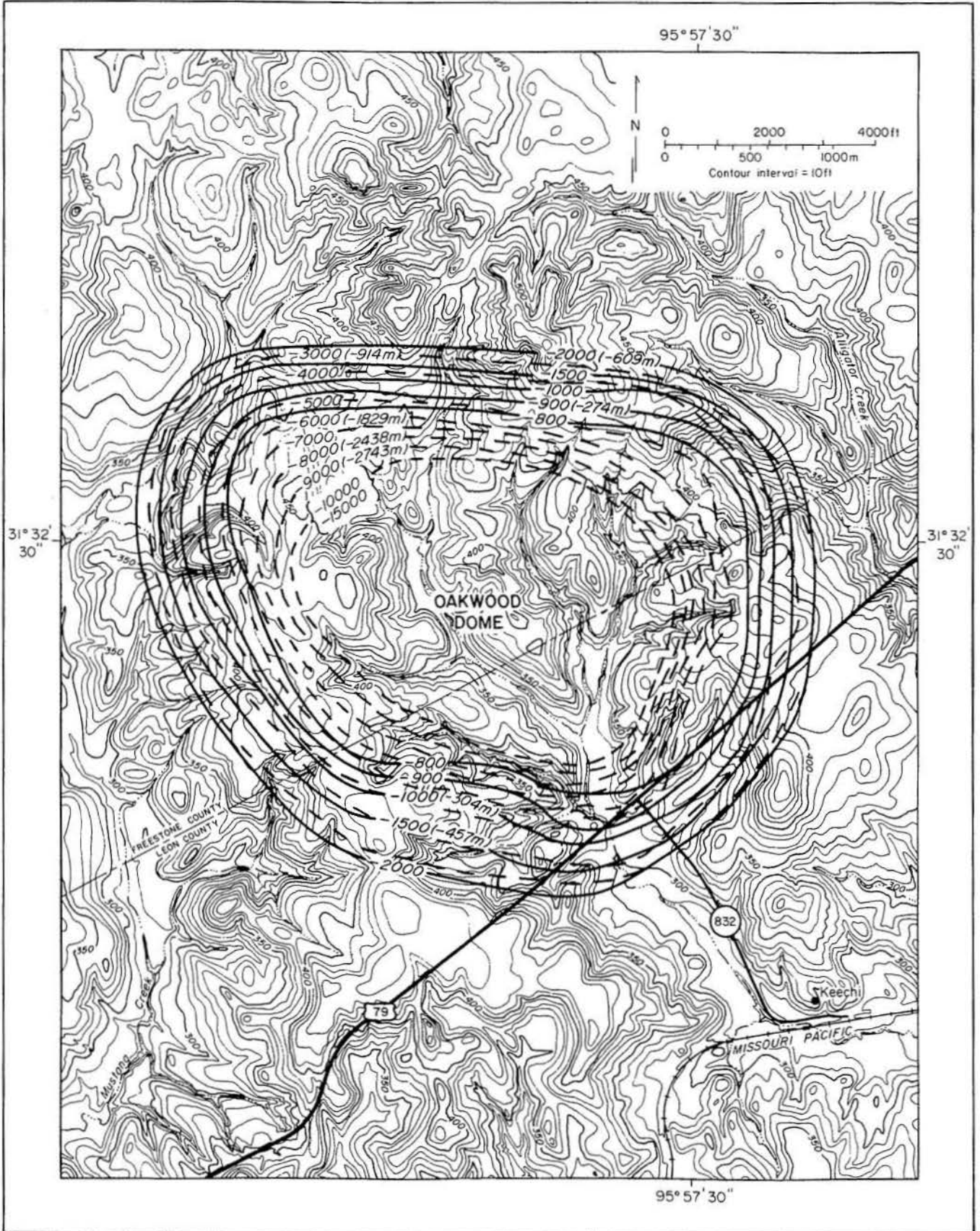

Figure 65. Map showing shape, location, topography, and drainage system of Oakwood Dome (salt structure contours modified from Exploration Techniques, 1979).

OAKWOOD DOME (continued)

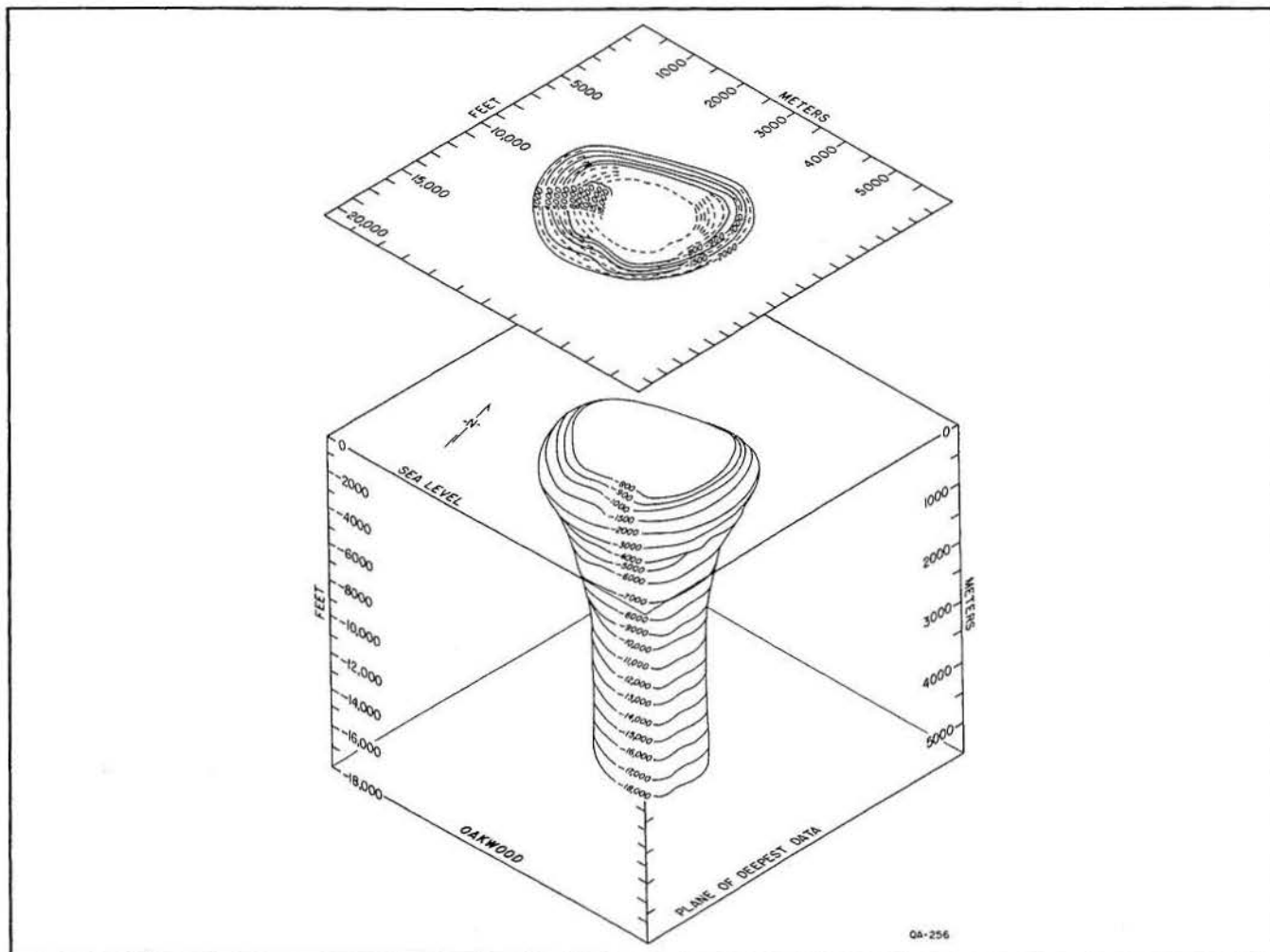

Figure 66. Isometric block diagram of Oakwood salt stock.

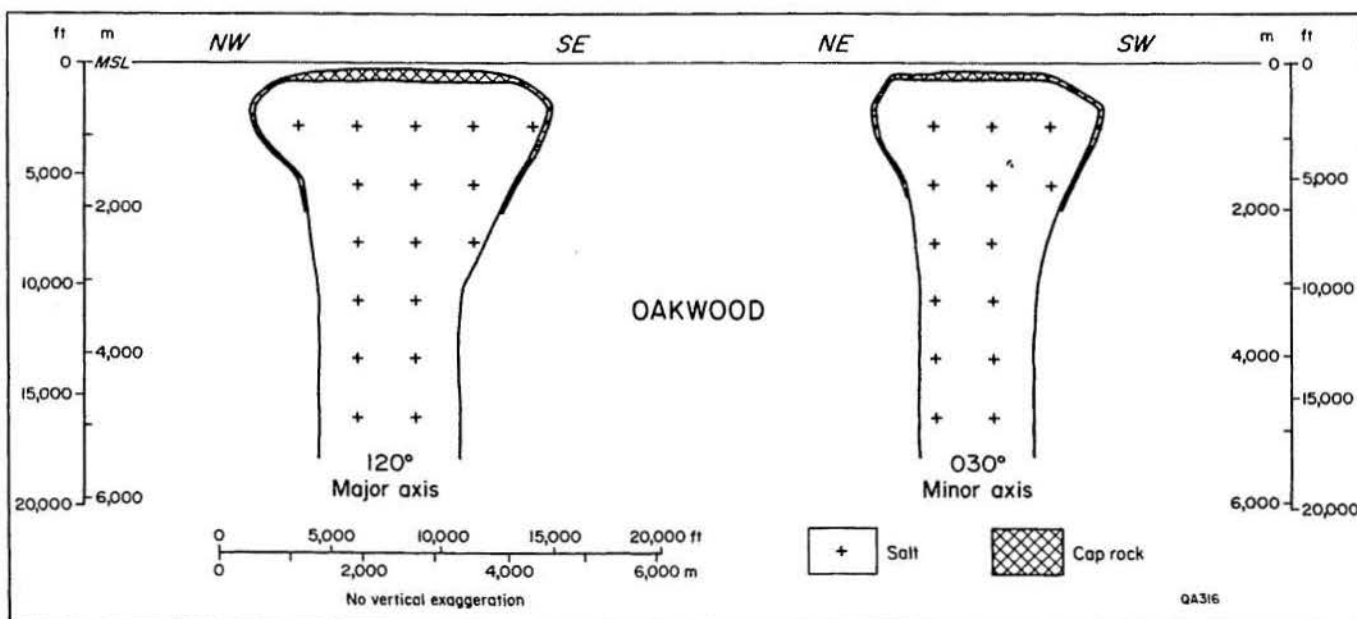
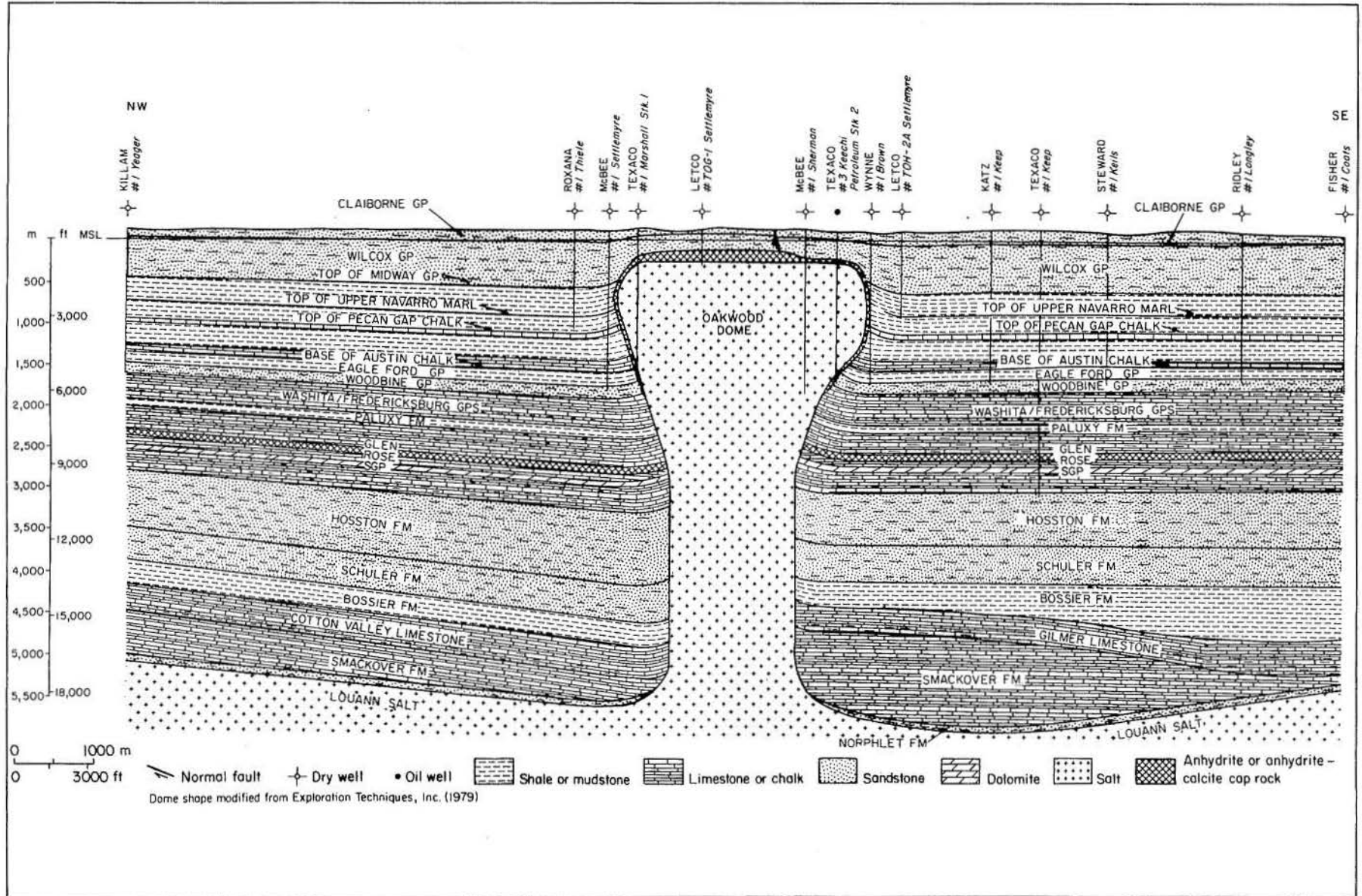

Figure 67. Orthogonal cross sections through major and minor axes of Oakwood salt stock.



OAKWOOD DOME (continued)

Figure 68. Structural cross section through Oakwood Dome, based on drilling and seismic data (modified from Giles and Wood, 1981).

DOME NAME: PALESTINE

LOCATION:

SW Anderson Co.
31° 44' 13" N; 95° 43' 41" W

RESIDUAL GRAVITY EXPRESSION:

-110 G units

DEPTH:

Depth to Cap Rock:

120 ft (37 m)

Depth to Salt Stock:

122 ft (37 m)

Depth to Top of Louann Salt (approximate):

22,000 ft (6,700 m)

ORIENTATION AND MAXIMUM LATERAL DIMENSIONS OF SALT STOCK:

Major Axis:

Length:

3.4 mi (5.4 km) at -20,000 ft (-6,096 m)

Orientation:

170°

Minor Axis:

Length:

2.7 mi (4.3 km)

Area:

7.0 mi² (17.9 km²)

Area of Planar Crest:

0.7 mi² (1.8 km²)

Percentage Planar Crest:

11%

SHAPE OF SALT STOCK:

General:

Piercement stock

Plan:

Elliptical (axial ratio = 1.3)

Cross Section:

Axis:

Axial plunge 82°; tilt direction 094°;
tilt distance 1,584 ft (483 m)

Approximate Overall Symmetry:

Monoclinic

Crest:

Conical-planar

Sides:

Nearly parallel from -15,000 ft to
-7,000 ft (-4,572 m to -2,134 m);
upward converging above -7,000 ft
(-2,134 m)

Overhang:

Well developed, E flank only; elevation
-6,000 ft (-1,829 m); maximum lateral
overhang 2,640 ft (805 m), percentage
overhang 11%

CAP ROCK:

Maximum Stratigraphic Thickness:

32 ft (10 m)

Minimum Stratigraphic Thickness:

9 ft (3 m)

Composition:

Calcite, calcite-cemented Carrizo Formation
as false cap rock

GEOMETRY OF ADJOINING STRATA:

Lateral Extent of Rim Syncline:

32,000 ft (9,754 m)

Lateral Extent of Drag Zone:

16,200 ft (4,938 m)

Vertical Variation in Maximum Dip of Strata:

$\Delta \approx -10^\circ$ at -10,800 ft (-3,292 m)
(Travis Peak)

$\Delta = 0^\circ$ at -6,000 ft (-1,829 m) (Washita)

$\Delta = 40^\circ$ at -4,500 ft (-1,372 m) (Austin)

$\Delta = 20^\circ$ at -1,800 ft (-449 m) (Wilcox)

Angle Between Salt and Surrounding Strata:

$\delta = 90^\circ$ from -11,000 ft to -7,500 ft
(-3,353 m to -2,286 m) (Travis Peak to Washita)

$\delta = 20^\circ$ to 30° at -2,500 ft (-762 m)
(Navarro Marl)

Contact fault below Woodbine Group

Oldest Planar Overburden:

Quaternary strata

FAULTING OF ADJACENT STRATA:

Faults at Flanks:

None

Crestal Faults:

Horst and graben, normal, homothetic, up-to-dome

PALESTINE DOME (continued)

Youngest Faulted Strata:

Claiborne Group

Oldest Strata at Surface:

Buda Limestone: stratigraphic evidence of doming at surface

GROWTH HISTORY:

PRIMARY PERIPHERAL SINK:

Age of Initiation:

150 Ma

Age of Cessation:

130 Ma

Duration of Growth:

20 Ma

Distance of Axial Trace from Center of Dome:

5 to 7 mi (8 to 12 km)

SECONDARY PERIPHERAL SINK:

Age of Initiation:

130 Ma

Age of Cessation:

120 Ma

TERTIARY PERIPHERAL SINK:

Age of Initiation:

120 Ma

Age of Cessation:

Post-50 Ma

AGE OF MIGRATION OF SINK TO SALT-STOCK CONTACT:

100 to 110 Ma

DOME-RELATED UNCONFORMITIES:

None recognized

Evidence of Extrusion and Erosion of Salt:

None recognized

YOUNGEST DEFORMATION:

Faults in Wilcox Group to surface

EVIDENCE OF SUBSIDENCE:

Present

Configuration of Overburden Strata:

Wilcox, Claiborne strata arch over dome; grabens over dome crest

Drainage System:

Type 2, central, supradomal depression, central centripetal drainage, man-made Duggey's Lake over center of dome

Sinkholes:

Common, 16 found, the 3 most recent forming in 1978, 1972, and 1956-58

Surface Salines:

Present, including Duggey's Lake

RESOURCES AND USES:

HYDROCARBONS:

Number of Producing Wells:

Current: 0

Total: 0

Production:

Current: 0

Total: 0

Stratigraphic Reservoir:

None

Traps:

None

ROCK SALT:

Solution-mined from 1904 to 1937

SULFUR:

None

GAS STORAGE:

None

PALESTINE DOME (continued)

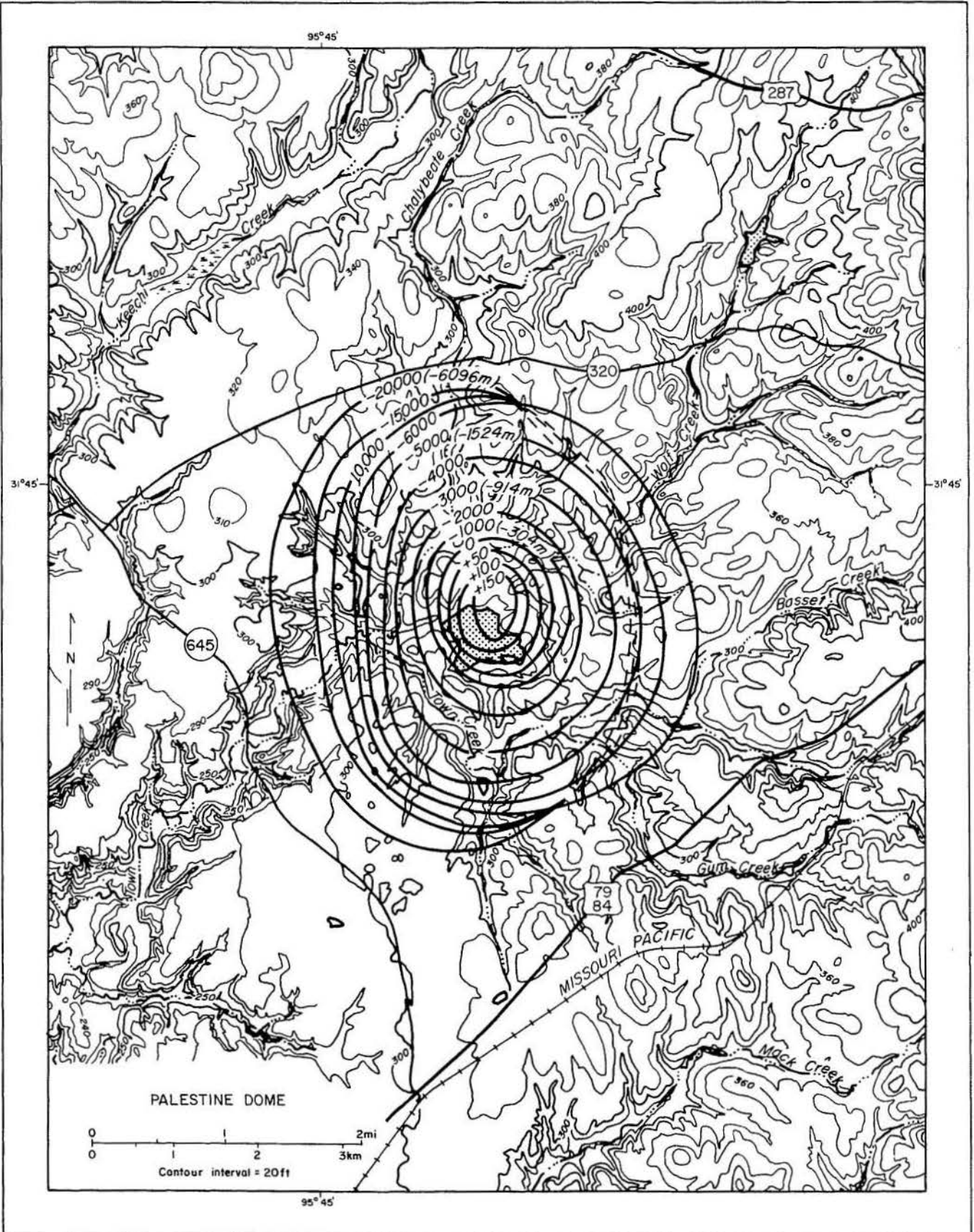

Figure 69. Map showing shape, location, topography, and drainage system of Palestine Dome (salt structure contours from Giles, 1980).

PALESTINE DOME (continued)

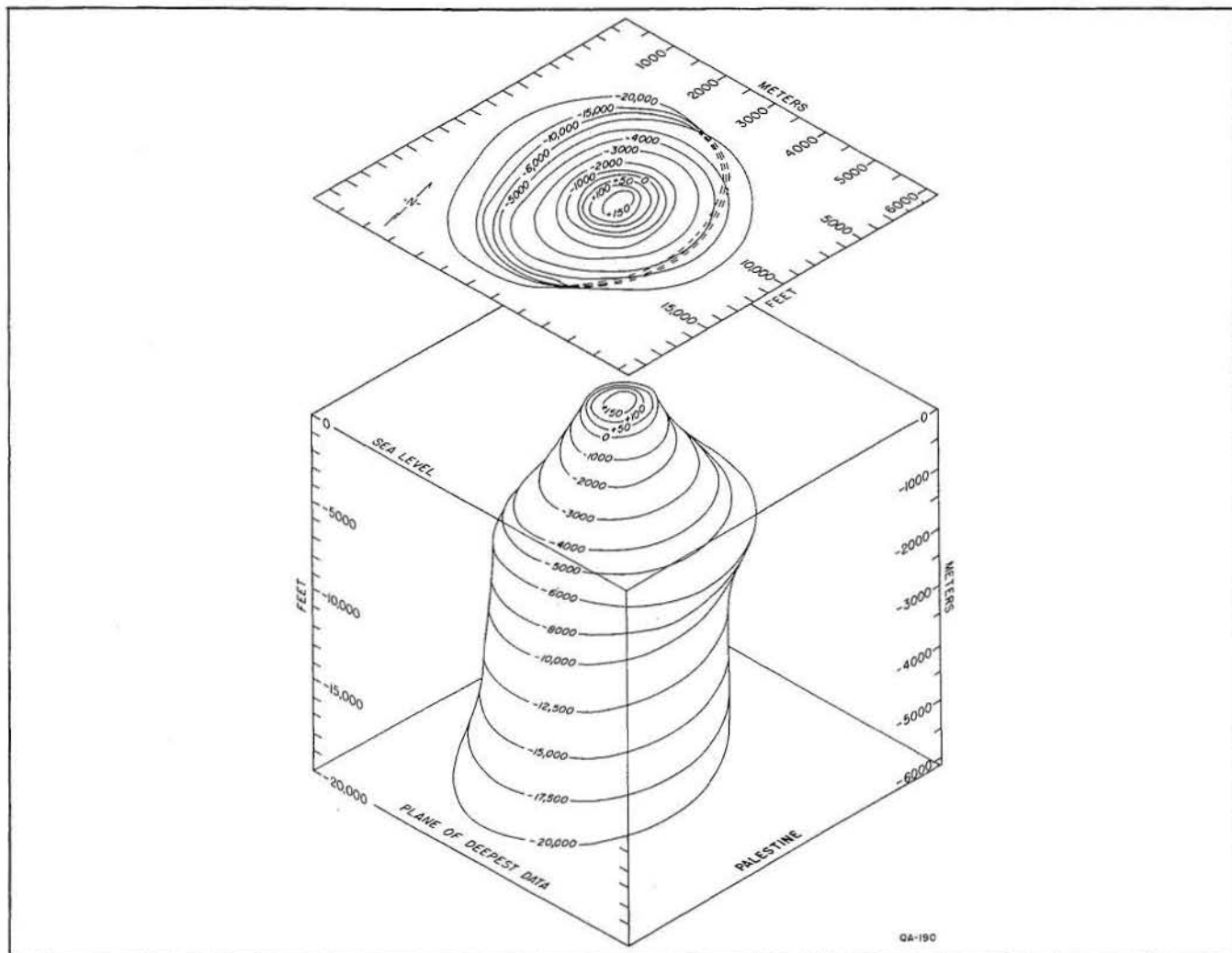

Figure 70. Isometric block diagram of Palestine salt stock.

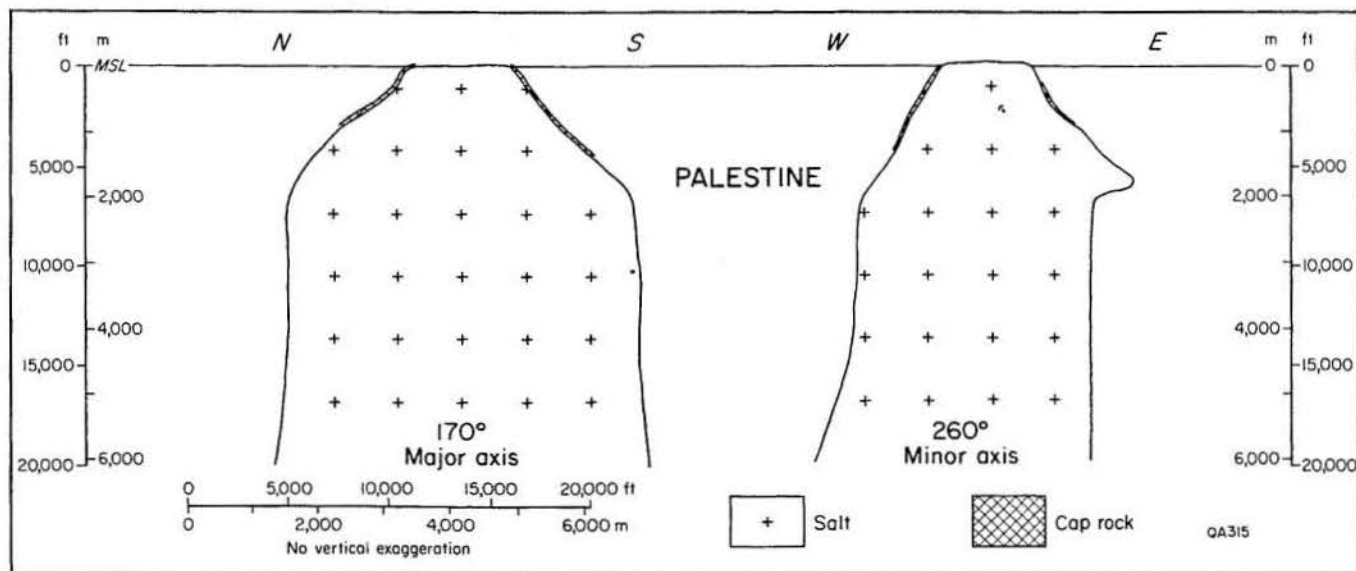
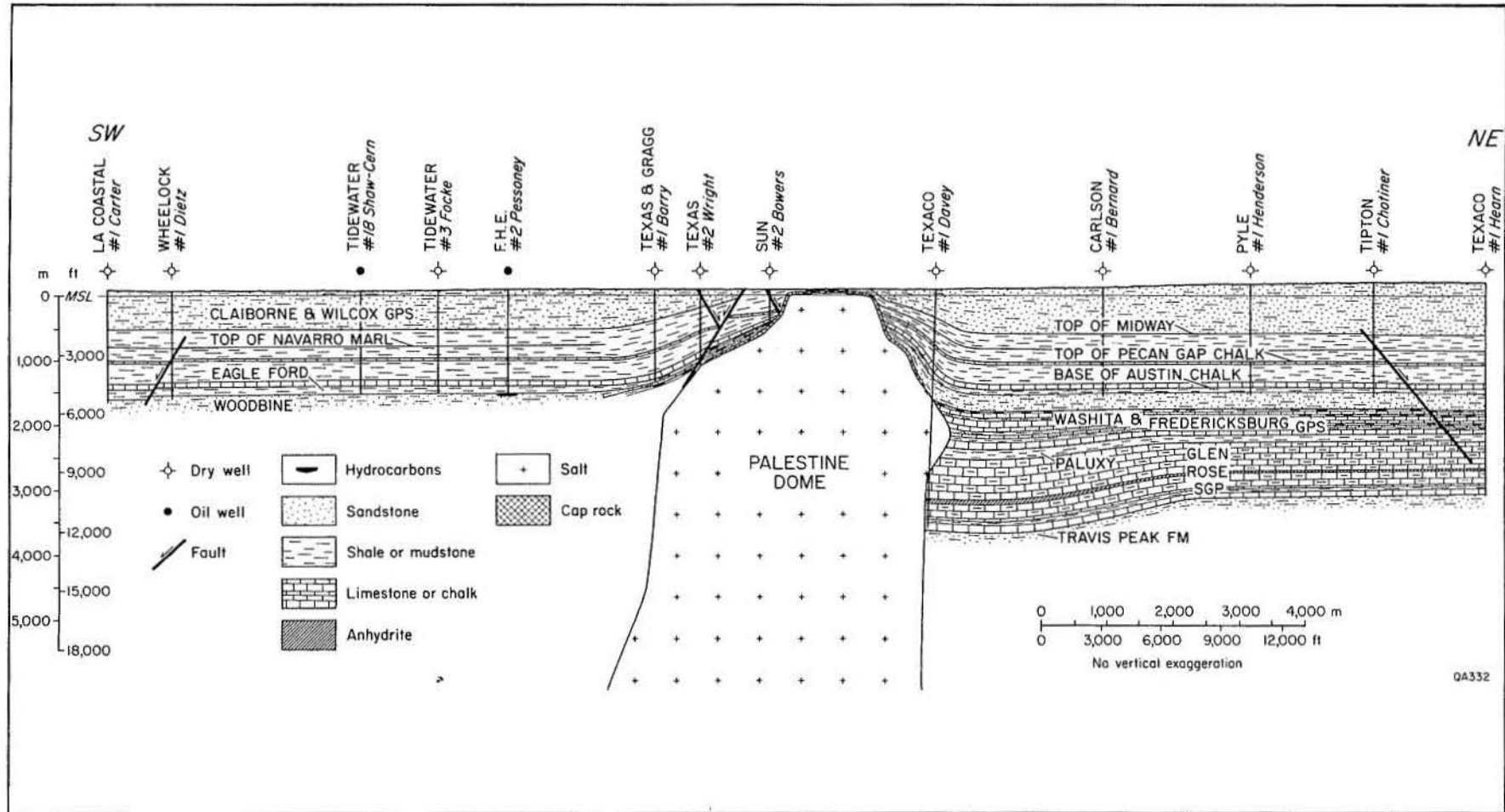

Figure 71. Orthogonal cross sections through major and minor axes of Palestine salt stock.



PALESTINE DOME (continued)

Figure 72. Structural cross section through Palestine Dome (Giles, 1980).

DOME NAME: STEEN

LOCATION:

North-central Smith Co.
32° 31' 0" N; 95° 19' 30" W

RESIDUAL GRAVITY EXPRESSION:

-54 G units

DEPTH:

Depth to Cap Rock:

75 ft (23 m)

Depth to Salt Stock:

300 ft (91 m)

Depth to Top of Louann Salt (approximate):

21,000 ft (6,400 m)

ORIENTATION AND MAXIMUM LATERAL DIMENSIONS OF SALT STOCK:

Major Axis:

Length:

2.2 mi (3.5 km)

Orientation:

045°

Minor Axis:

Length:

2.1 mi (3.4 km)

Area:

3.7 mi² (9.5 km²)

Area of Planar Crest:

0.5 mi² (1.3 km²)

Percentage Planar Crest:

14%

SHAPE OF SALT STOCK:

General:

Piercement stock

Plan:

Circular (axial ratio = 1.05)

Cross Section:

Axis:

Vertical

Approximate Overall Symmetry:

Axial

Crest:

Conical-planar

Sides:

Upward diverging from -8,000 ft to -6,000 ft (-2,438 m to -1,829 m); upward converging above -6,000 ft (-1,829 m); deepest data -8,000 ft (-2,438 m)

Overhang:

Moderate, circumdomal, symmetrical, elevation -6,000 ft (-1,829 m); maximum lateral overhang 1,000 ft (305 m) on S flank; percentage overhang 14%

CAP ROCK:

Maximum Stratigraphic Thickness:

200 ft (61 m)

Minimum Stratigraphic Thickness:

9 ft (3 m)

Composition:

Calcite, anhydrite

GEOMETRY OF ADJOINING STRATA:

Lateral Extent of Rim Syncline:

27,750 ft (8,458 m)

Lateral Extent of Drag Zone:

12,000 ft (3,658 m)

Vertical Variation in Maximum Dip of Strata:

$\Delta = -15^\circ$ at -8,200 ft (-2,499 m)
(Glen Rose)

$\Delta = 0^\circ$ at -3,000 ft (-914 m) (Pecan Gap)

$\Delta = +50^\circ$ at -4,000 ft (-1,219 m) (Eagle Ford)

Angle Between Salt and Surrounding Strata:

$\delta = 90^\circ$ from -10,000 ft (-3,048 m)
(lower Glen Rose) to -4,600 ft (-1,402 m)
(Eagle Ford)

$\delta = 0^\circ$ to 60° to crest

Contact fault below Claiborne Group

Oldest Planar Overburden:

Claiborne Group

FAULTING OF ADJACENT STRATA:

Faults at Flanks:

E side: normal, up-to-dome, antithetic, multiple-offset graben system on crest of broad anticline; growth faulting from Paluxy to Woodbine. W side: normal, down-to-dome, homothetic fault (Woodbine ? in age)

STEEN DOME (continued)

Crestal Faults:

None

Youngest Faulted Strata:

Woodbine Group

Oldest Strata at Surface:

Queen City Formation: no stratigraphic evidence of doming at surface

GROWTH HISTORY:

PRIMARY PERIPHERAL SINK:**Age of Initiation:**

Pre-110 Ma

Age of Cessation:

Pre-110 Ma

Duration of Growth:

Unknown

Distance of Axial Trace from Center of Dome:

3 to 4 mi (5 to 6 km)

SECONDARY PERIPHERAL SINK:**Age of Initiation:**

Pre-110 Ma

Age of Cessation:

70 Ma

TERTIARY PERIPHERAL SINK:**Age of Initiation:**

70 Ma

Age of Cessation:

Post-50 Ma

AGE OF MIGRATION OF SINK TO SALT-STOCK CONTACT:

100 Ma

DOME-RELATED UNCONFORMITIES:

None recognized

Evidence of Extrusion and Erosion of Salt:

None recognized

YOUNGEST DEFORMATION:

Arched Claiborne strata

EVIDENCE OF SUBSIDENCE:

Equivocal

Configuration of Overburden Strata:

Claiborne strata arch over dome

Drainage System:

Type 3, central supradomal depression, subcentripetal drainage

Sinkholes:

None

Surface Salines:

Present

RESOURCES AND USES:

HYDROCARBONS:

Fender field

Number of Producing Wells:

Current: 1

Total: 3

Production:

Current: 11,790 bbl; 0 Mcf

Total: 187,022 bbl; 0 Mcf

Stratigraphic Reservoir:

Rodessa Member

Traps:

Beneath overhang

ROCK SALT:

Solution mined during the Civil War

SULFUR:

None

GAS STORAGE:

None

STEEN DOME (continued)

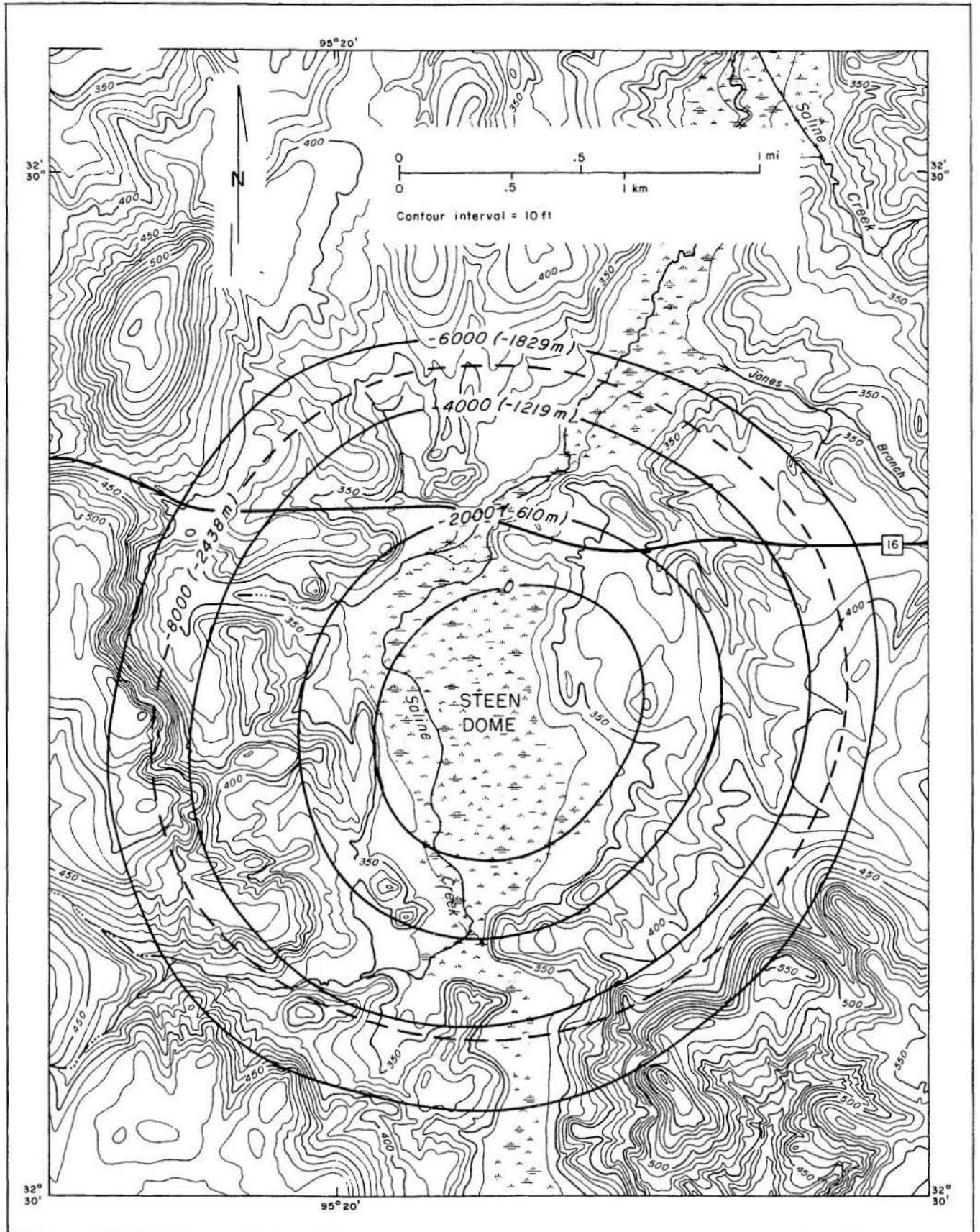

Figure 73. Map showing shape, location, topography, and drainage system of Steen Dome (salt structure contours from Giles, 1980).

STEEN DOME (continued)

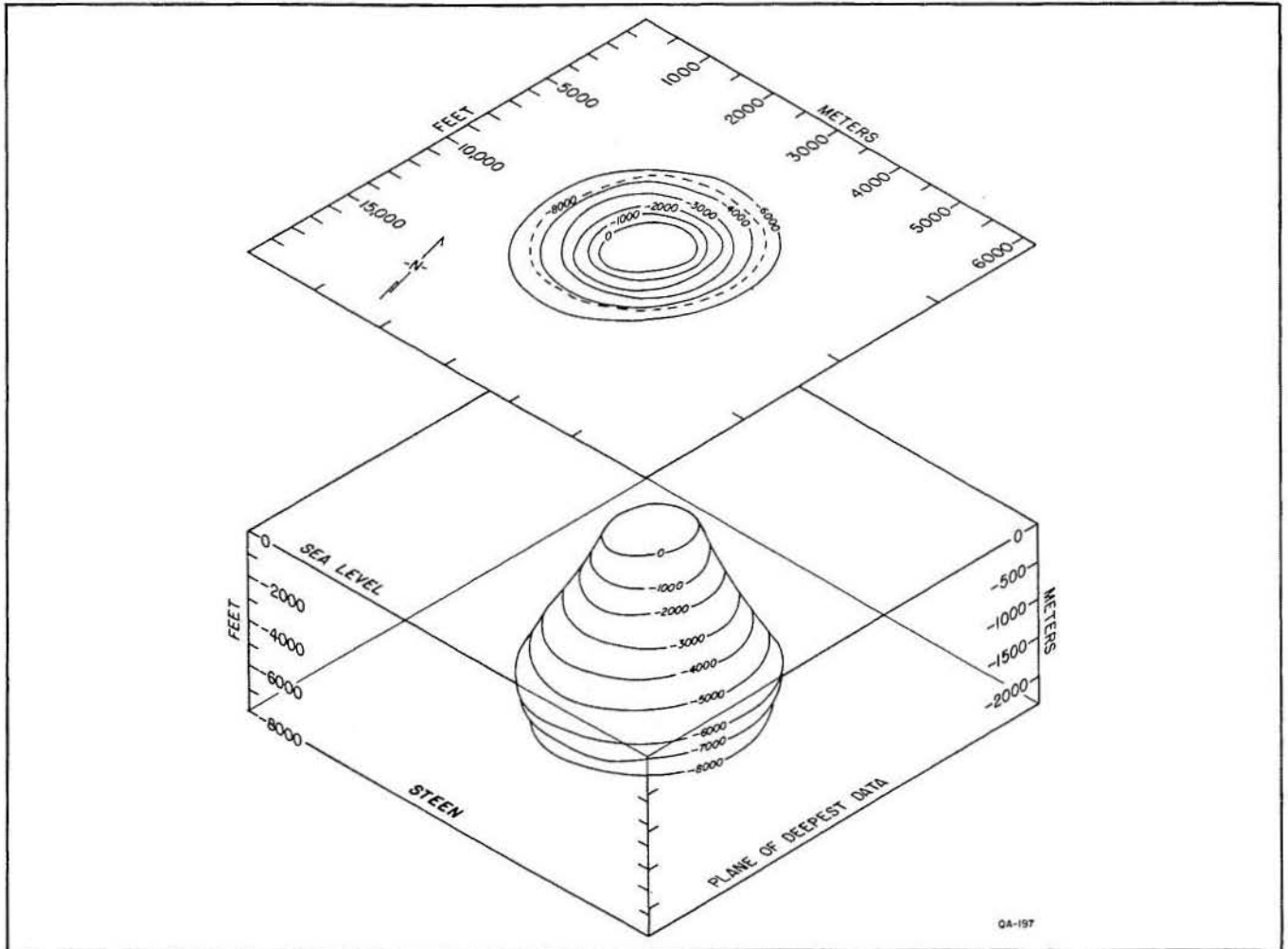

Figure 74. Isometric block diagram of Steen salt stock.

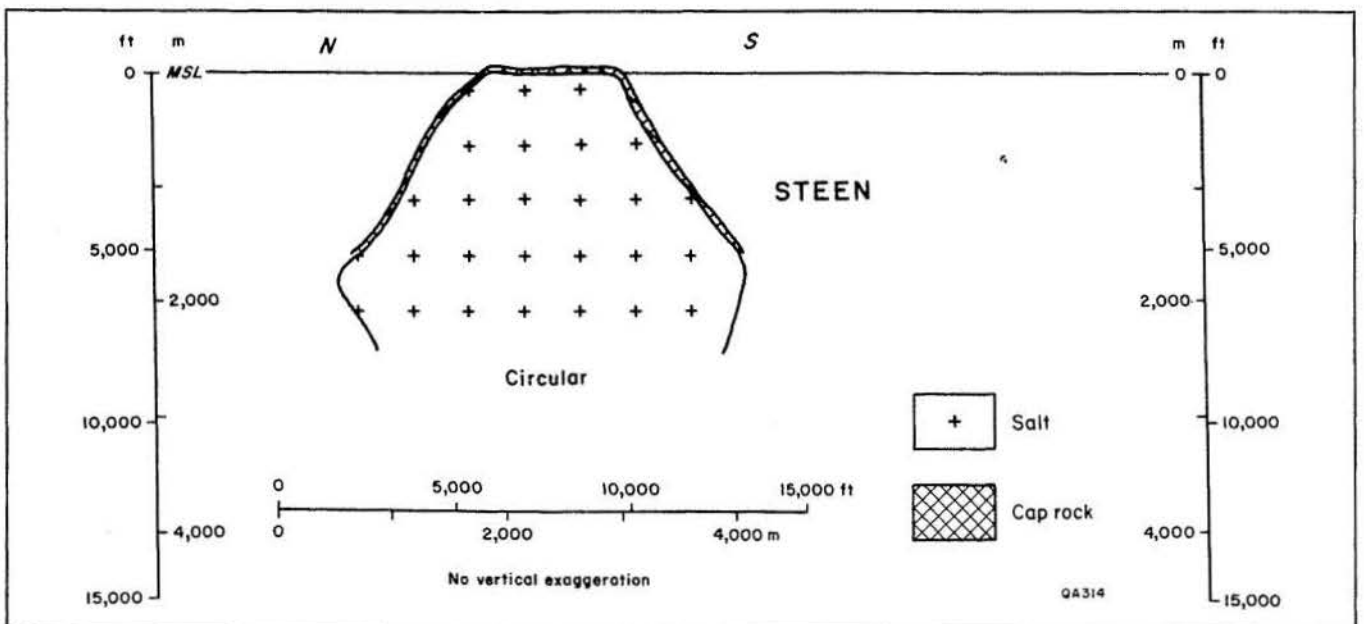
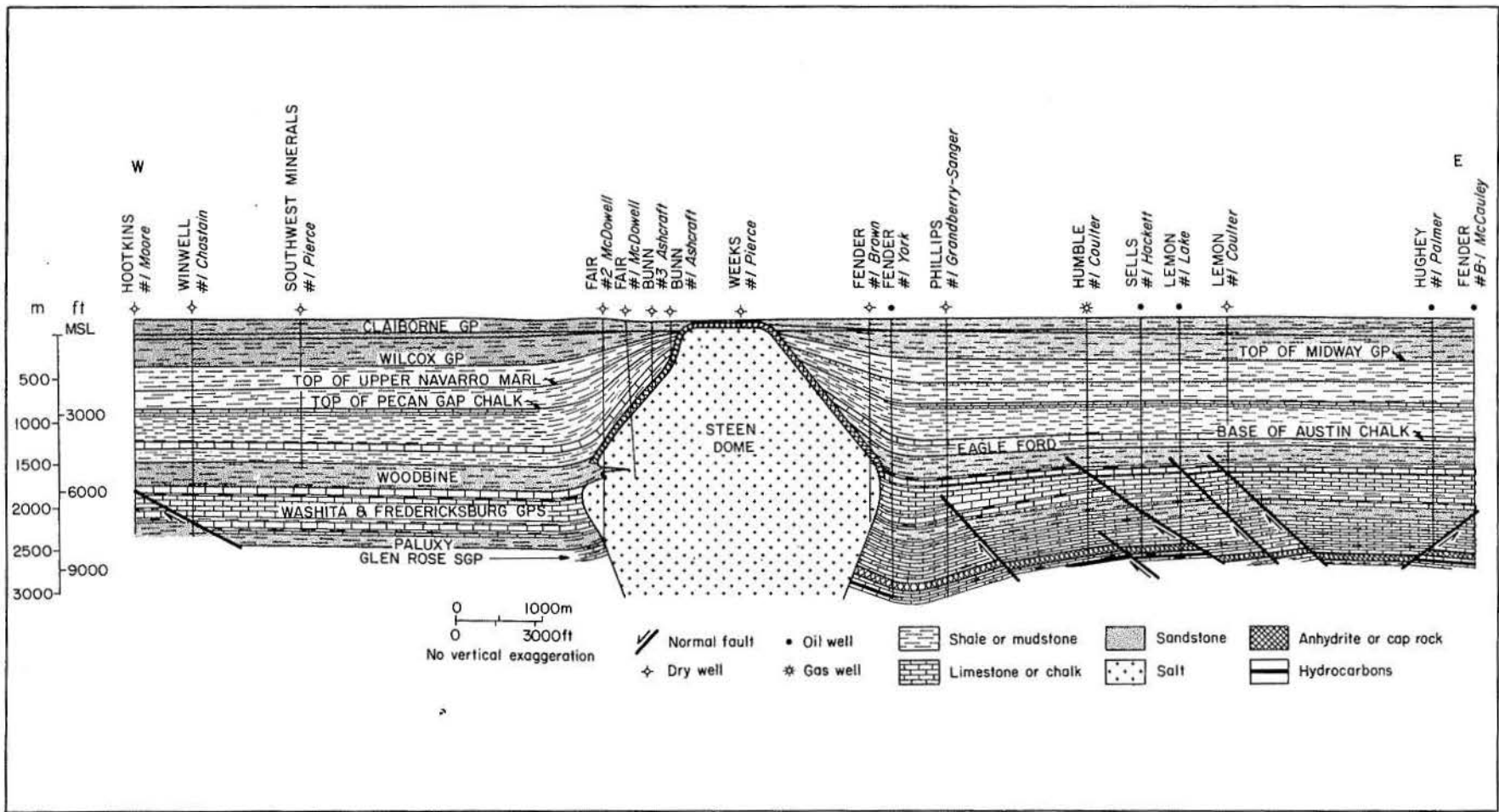

Figure 75. Cross sections through Steen salt stock, which is axially symmetric.



STEEN DOME (continued)

Figure 76. Structural cross section through Steen Dome (Wood and Giles, 1982).

DOME NAME: WHITEHOUSE

LOCATION:

South-central Smith Co.
32° 13' 27" N; 95° 17' 03" W

RESIDUAL GRAVITY EXPRESSION:

-76 G units

DEPTH:

Depth to Cap Rock:

485 ft (148 m)

Depth to Salt Stock:

535 ft (163 m)

Depth to Top of Louann Salt (approximate):

22,000 ft (6,700 m)

ORIENTATION AND MAXIMUM LATERAL DIMENSIONS OF SALT STOCK:

Major Axis:

Length:

2.6 mi (4.2 km)
at -6,000 ft
(-1,829 m)

Orientation:

015°

Minor Axis:

Length:

1.3 mi (2.1 km)

Area:

2.6 mi² (6.7 km²)

Area of Planar Crest:

0.2 mi² (0.5 km²)

Percentage Planar Crest:

8%

Major Axis:

Length:

> 3.0 mi (> 4.8 km)
at -10,000 ft
(-3,048 m)

Orientation:

007°

Minor Axis:

Length:

> 2.1 mi (> 3.4 km)

Area:

> 5.3 mi² (> 13.6 km²)

SHAPE OF SALT STOCK:

General:

Piercement stock

Plan:

Irregular lobate-elliptical (axial ratio = 1.3)
at -15,000 ft (-4,572 m); elliptical (axial
ratio = 2.0) at -6,000 ft (-1,829 m)

Cross Section:

Axis:

Axial plunge 84°; tilt direction 095°;
tilt distance 1,584 ft (483 m)

Approximate Overall Symmetry:

Triclinic

Crest:

Conical

Sides:

Upward converging from -15,000 ft to
-8,000 ft (-4,572 m to -2,438 m);
upward diverging from -8,000 ft to
-6,000 ft (-2,438 m to -1,829 m);
upward converging above -6,000 ft
(-1,829 m); deepest data -15,000 ft
(-4,572 m)

Overhang:

Irregular, maximum development on NNE
flank, elevation -6,000 ft (-1,829 m);
maximum lateral overhang 4,910 ft
(1,497 m) on NNE flank; percentage
overhang 53%

CAP ROCK:

Maximum Stratigraphic Thickness:

70 ft (21 m)

Minimum Stratigraphic Thickness:

50 ft (15 m)

Composition:

Anhydrite, calcite

GEOMETRY OF ADJOINING STRATA:

Lateral Extent of Rim Syncline:

21,750 ft (6,629 m)

Lateral Extent of Drag Zone:

17,250 ft (5,258 m)

Vertical Variation in Maximum Dip of Strata:

$\Delta = -1^\circ$ at -4,900 ft (-1,494 m) (Washita)
 $\Delta = 0^\circ$ at -4,000 ft (-1,219 m) (Eagle Ford)
 $\Delta = +10^\circ$ at -2,600 ft (-792 m) (Pecan Gap)
 $\Delta = +30^\circ$ at -800 ft (-244 m) (Claiborne)

Angle Between Salt and Surrounding Strata:

$\delta = 20^\circ$ at -6,000 ft (-1,829 m)
(Fredericksburg)

$\delta = 50^\circ$ at -1,700 ft (-518 m) to crest

Contact fault below Claiborne Group

Oldest Planar Overburden:

Quaternary strata

WHITEHOUSE DOME (continued)

FAULTING OF ADJACENT STRATA:

Faults at Flanks:

N side: normal, up-to-dome, multiple offset, antithetic (Fredericksburg age)

Crestal Faults:

None

Youngest Faulted Strata:

Fredericksburg Group

Oldest Strata at Surface:

Queen City Formation: stratigraphic evidence of doming at surface

GROWTH HISTORY:

PRIMARY PERIPHERAL SINK:

Age of Initiation:

Pre-110 Ma

Age of Cessation:

Pre-110 Ma

Duration of Growth:

Unknown

Distance of Axial Trace from Center of Dome:

4 to 5 mi (6 to 8 km)

SECONDARY PERIPHERAL SINK:

Age of Initiation:

Pre-110 Ma

Age of Cessation:

Pre-110 Ma

TERTIARY PERIPHERAL SINK:

Age of Initiation:

Pre-110 Ma

Age of Cessation:

Post-50 Ma

AGE OF MIGRATION OF SINK TO SALT-STOCK CONTACT:

Unknown

DOME-RELATED UNCONFORMITIES:

N side: Woodbine Group (overlapped by Eagle Ford and Austin Groups) pinches out domeward over unconformity on top of Washita Group

Evidence of Extrusion and Erosion of Salt:

None recognized

YOUNGEST DEFORMATION:

Wilcox strata arch over dome

EVIDENCE OF SUBSIDENCE:

Absent

Configuration of Overburden Strata:

Claiborne strata flat-lying

Drainage System:

Type 3, subcentripetal drainage

Sinkholes:

None

Surface Salines:

None

RESOURCES AND USES:

HYDROCARBONS:

Number of Producing Wells:

Current: 0

Total: 0

Production:

Current: 0

Total: 0

Stratigraphic Reservoir:

None

Traps:

None

ROCK SALT:

Not mined

SULFUR:

None

GAS STORAGE:

None

WHITEHOUSE DOME (continued)

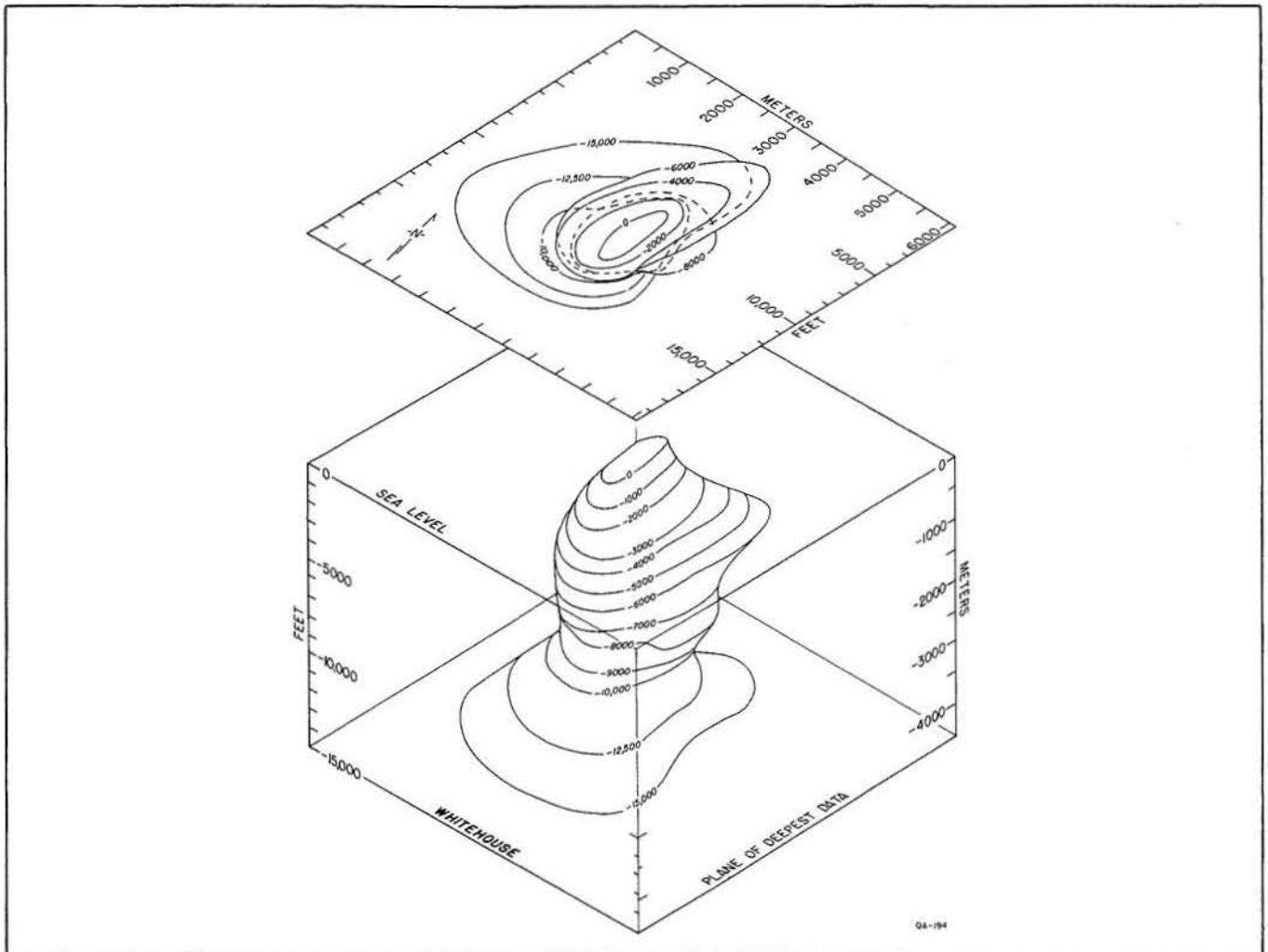

Figure 77. Isometric block diagram of Whitehouse salt stock. See figure 36 for shape, location, topography, and drainage system of Whitehouse Dome.

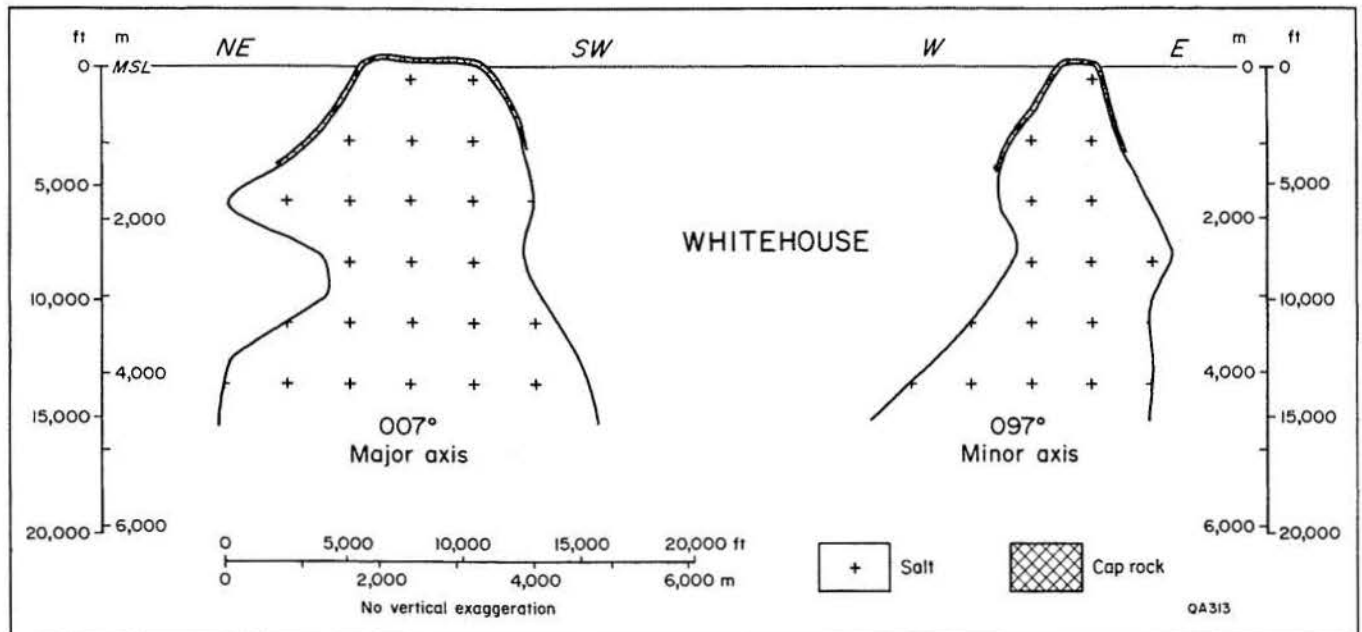
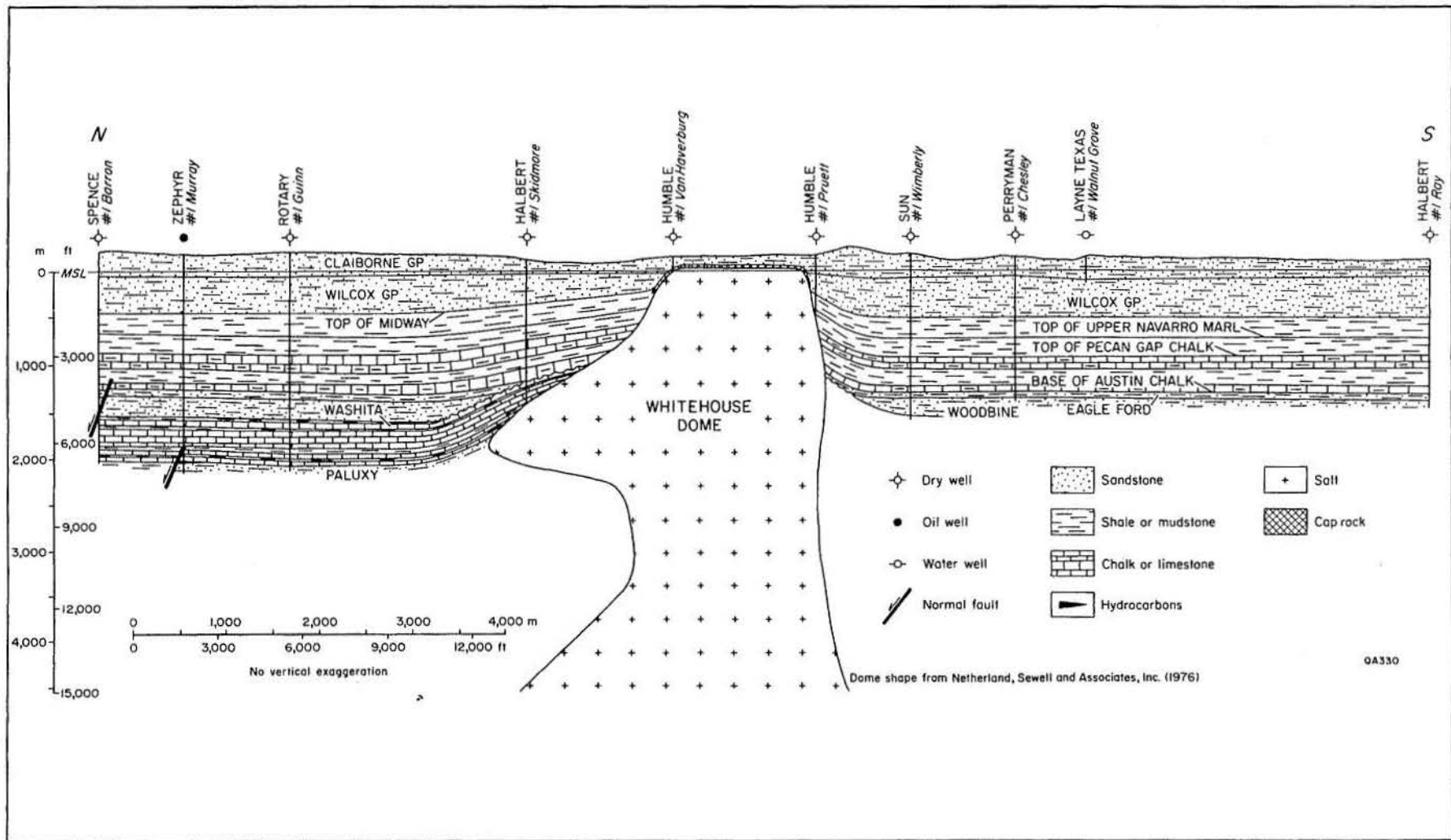

Figure 78. Orthogonal cross sections through major and minor axes of Whitehouse salt stock.



WHITEHOUSE DOME (continued)

Figure 79. Structural cross section through Whitehouse Dome (Giles, 1980).

ACKNOWLEDGMENTS

Funding for this research was provided by the U. S. Department of Energy under Contract No. DE-AC97-80ET46617. L. F. Brown, Jr., G. E. Fogg, C. W. Kreitler, M. A. Fracasso, W. W. Simpkins, and S. J. Tewalt of the Bureau of Economic Geology, and anonymous reviewers of the East Texas Geological Society critically reviewed the manuscript; their comments are gratefully acknowledged. A. B. Giles, O. Agagu, E. H. Guevara, and D. H. Wood initiated data collection, and provided a regional structural-stratigraphic framework. G. E. Fogg located the domes on a topographic base. In addition to constructing all and publishing many of the dome cross sections, A. B. Giles also constructed most of the salt structure contour maps of individual domes, both of which are an important component of this atlas. The following research assistants labored diligently on data collection and synthesis: R. Cobb, R. Conti, S. Cumella, D. Dann, E. Duncan, S. Ghazi, S. Lovell, J. McIntyre, G. Meyer, E. Pisasale, R. Sherrill, and T. Simmons. Manuscript preparation was facilitated by the computer wizardry of K. L. Milliken. Word processing was done by Jana McFarland and Twyla J. Coker and typesetting was by Fannie M. Sellingsloh under the supervision of Lucille C. Harrell. John T. Ames, Mark T. Bentley, Thomas M. Byrd, Micheline R. Davis, Margaret L. Evans, Richard P. Flores, Jeff S. Horowitz, and Jamie A. McClelland drafted the figures under the supervision of Dan Scranton and Richard L. Dillon. Text illustration photography was by James A. Morgan. The publication was designed by Margaret L. Evans and edited by Amanda R. Masterson.

REFERENCES

- Cloos, Ernst, 1968, Experimental analysis of Gulf Coast fracture patterns: American Association of Petroleum Geologists Bulletin, v. 52, no. 3, p. 420-444.
- Cloos, Hans, 1928, Uber antithetische Bewegungen: Geologische Rundschau, v. 19, no. 3, p. 249-251.
- Collins, E. W., Dix, O. R., and Hobday, D. K., 1981, Oakwood salt dome, East Texas: surface geology and drainage analysis: The University of Texas at Austin, Bureau of Economic Geology Geological Circular 81-6, 23 p.
- Dennis, J. G., and Kelley, V. C., 1980, Antithetic and homothetic faults: Geologische Rundschau, v. 69, no. 1, p. 186-193.
- Exploration Techniques, Inc., 1979, Report on gravity modeling for Keechi and Oakwood Domes: Report prepared for Law Engineering Testing Co., Houston, Texas, unpaginated.
- Galloway, W. E., Ewing, T. E., Garrett, C. M., Tyler, N., and Bebout, D. G., 1983, Atlas of major Texas oil reservoirs: The University of Texas at Austin, Bureau of Economic Geology, Special Publication, 139 p.
- Giles, A. B., 1980, Unpublished structure-contour maps and cross sections of East Texas salt domes on open file at the Bureau of Economic Geology, The University of Texas at Austin.
- Giles, A. B., 1981, Geometry of East Texas salt diapirs, *in* Kreitler, C. W., and others, Geology and geohydrology of the East Texas Basin, a report on the progress of nuclear waste isolation feasibility studies (1980): The University of Texas at Austin, Bureau of Economic Geology Geological Circular 81-7, p. 33-38.
- Giles, A. B., and Wood, D. H., 1981, Petroleum accumulation patterns in the East Texas salt dome area, *in* Kreitler, C. W., and others, Geology and geohydrology of the East Texas Basin, a report on the progress of nuclear waste isolation feasibility studies (1980): The University of Texas at Austin, Bureau of Economic Geology Geological Circular 81-7, p. 69-77.
- 1983, Oakwood salt dome, East Texas: geologic framework, growth history, and hydrocarbon production: The University of Texas at Austin, Bureau of Economic Geology Geological Circular 83-1, 55 p.

- Jackson, M. P. A., and Seni, S. J., 1983, Geometry and evolution of salt structures in a marginal rift basin of the Gulf of Mexico, East Texas: *Geology*, v. 11, no. 3, p. 131-135.
- _____, 1984, Suitability of salt domes in the East Texas Basin for nuclear waste isolation: final summary of geologic and hydrologic research (1978-1983): The University of Texas at Austin, Bureau of Economic Geology Geological Circular 84-1, 128 p.
- Kreitler, C. W., and others, 1980, Geology and geohydrology of the East Texas Basin, a report on the progress of nuclear waste isolation feasibility studies (1979): The University of Texas at Austin, Bureau of Economic Geology Geological Circular 80-12, 112 p.
- _____, 1981, Geology and geohydrology of the East Texas Basin, a report on the progress of nuclear waste isolation feasibility studies (1980): The University of Texas at Austin, Bureau of Economic Geology Geological Circular 81-7, 207 p.
- Lobeck, A. K., 1924, Block diagrams and other methods used in geology and geography: New York, John Wiley, 186 p.
- Loocke, J. E., 1978, Growth history of the Hainesville salt dome, Wood County, Texas: The University of Texas at Austin, Master's thesis, 95 p.
- Lotze, F., 1931, *Über Zerrungsformen*: *Geologische Rundschau*, v. 22, no. 6, p. 353-371.
- Martin, R. G., 1978, Northern and eastern Gulf of Mexico continental margin: stratigraphic and structural framework: American Association of Petroleum Geologists Studies in Geology No. 7, p. 21-42.
- Netherland, Sewell and Associates, 1976, Geologic study of the interior salt domes of northeast Texas salt dome basin to investigate their suitability for possible storage of radioactive waste material as of May, 1976: Report prepared for the Office of Waste Isolation, Energy Research and Development Administration, Union Carbide Corporation, Nuclear Division, 57 p.
- Ramberg, Hans, 1981, Gravity, deformation and the Earth's crust in theory, experiments and geological application, second edition: London, Academic Press, 452 p.
- Ramsay, J. G., 1967, Folding and fracturing of rocks: New York, McGraw-Hill, 568 p.
- Seni, S. J., and Jackson, M. P. A., 1983a, Evolution of salt structures, East Texas diapir province, part 1: sedimentary record of halokinesis: *American Association of Petroleum Geologists Bulletin*, v. 67, no. 8, p. 1219-1244.
- _____, 1983b, Evolution of salt structures, East Texas diapir province, part 2: patterns and rates of halokinesis: *American Association of Petroleum Geologists Bulletin*, v. 67, no. 8, p. 1245-1274.
- _____, 1984, Sedimentary record of Cretaceous and Tertiary salt movement, East Texas Basin: times, rates, and volumes of salt flow and their implications for nuclear waste isolation and petroleum exploration: The University of Texas at Austin, Bureau of Economic Geology Report of Investigations No. 139, 89 p.
- Smith, D. A., and Reeve, F. A. E., 1970, Salt piercement in shallow Gulf Coast salt structures: *American Association of Petroleum Geologists Bulletin*, v. 54, no. 7, p. 1271-1289.
- Trusheim, Ferdinand, 1960, Mechanism of salt migration in northern Germany: *American Association of Petroleum Geologists Bulletin*, v. 44, no. 9, p. 1519-1540.
- Turk, Kehle and Associates, 1978, Tectonic framework and history, Gulf of Mexico region: report prepared for Law Engineering Testing Co., Marietta, Georgia, 29 p.
- Turner, F. J., and Weiss, L. E., 1963, Structural analysis of metamorphic tectonites: New York, McGraw-Hill, 545 p.
- Wilson, Gilbert, 1982, Introduction to small-scale geological structures: London, Allen and Unwin, 128 p.

Wood, D. H., and Giles, A. B., 1982, Hydrocarbon accumulation patterns in the East Texas salt dome province: The University of Texas at Austin, Bureau of Economic Geology Geological Circular 82-6, 36 p.

Wood, D. H., and Guevara, E. H., 1981, Regional structural cross sections and general stratigraphy, East Texas Basin: The University of Texas at Austin, Bureau of Economic Geology Cross Section, 21 p.